

BakeMax[®]

www.BakeMax.com

2024 FOODSERVICE EQUIPMENT CATALOG



Think Quality - Think Value - Think Service - Think BakeMax



www.BakeMax.com | 1-800-565-BAKE (2253)

Our Message

With over 50 years in the Food Service industry, we take pride in the products we offer to our customers throughout North America. From our Mixers to Ranges and everything in between, the BakeMax® & BakeMax America® family of products dates all the way back to 1966. What makes our brand so special is the quality of our products combined with the knowledge and experience of our staff.

The team at TVI is here to serve you, the customer. We strive to excel in customer support of our BakeMax® & BakeMax America® product lines before and after the sale. If you have not experienced the value of a BakeMax® & BakeMax America® products, why not find out why we are one of the fastest growing brands in North America.

BakeMax & BakeMax America is registered trademarks of (TVI) Titan Ventures International Inc.

Here to serve you,

Your BakeMax® Team

Find us on Auto Quotes



Want to be a BakeMax Dealer or Representative?

Email us at Sales@BakeMax.com or Call 1-800-565-2253

Want to be an Authorized Service Company for BakeMax?

Email us at Service@BakeMax.com or Call 1-800-565-2253

Looking for BakeMax OEM Parts?

Email us at Info@BakeMax.com or Call 1-800-565-2253

Equipment Approvals



Contact Information

Sales: Sales@BakeMax.com

Purchase Orders: OrderDesk@BakeMax.com

Service: Service@BakeMax.com

General Inquiries: 1-800-565-2253

Head Office:

Titan Ventures International
20 Caribou St

Moncton, NB E1H 0P3

Toll Free: 1-800-565-2253

Fax: 506-859-6929

Think Quality - Think Value - Think Service - Think BakeMax



Table of Contents

Bakery & Pizza Equipment

Countertop Planetary Mixers	P4
Floor Model Planetary Mixers	P5-6
Mixing Dough Capacity Chart	P7
Spiral Mixers	P8-11
Countertop Single Pass Sheeters	P12
Countertop Double Pass Sheeters	P13
Countertop Reversible Sheeters	P14
Floor Model Reversible Sheeters	P15
Dough Moulders	P16
Hand Bun Dividers	P17-18
Dough Dividers & Rounders	P19-25
Manual Pizza Presses	P26-27
Automatic Dough Presses	P28
Manual Tortilla Presses	P29
Tortilla Warmers	P30
Bread Slicers	P31-32
Pizza Warmers	P33
Water Meters	P34



Cooking Equipment

Artisan Stone Deck Ovens	P35-36
Radiant Gas Charbroilers	P37
Manual Gas Griddles	P38
Thermostatic Griddles	P39
Manual Gas Hot Plates	P40
Manual Gas Stock Pots	P41
Fryers	P42
Ranges	P43
Convection Ovens	P44-45
Air Fryers	P46-P48
Conveyor Toasters	P49
Conveyor Baker	P50



Food Preparation Equipment

Bone Saw & Bread Crumb Machine	P51
Meat Grinders	P52-53
Meat Slicers	P54
Vegetable Cutter & Slicer	P55

Display Cases

Heated Display Cases	P56-57
Refrigerated Display Cases	P58-59



Due to continuous product improvement, specifications are subject to change without notice.

Visit www.BakeMax.com for up-to-date product information.

1-800-565-2253

OrderDesk@BakeMax.com

Bakery & Pizza Equipment

Planetary Mixers

The BakeMax BMPM Series of Countertop Heavy Duty Planetary Mixers offers a space saving solution for cafes, restaurants, and bakeries tight on space. Our mixers provide durability, long life, and excellent mixing performance. They are safe, easy to use and capable of a broad range of dough and food mixing applications.



Model	BMPM007	BMPM012	BMPM20A	BMPM020
Bowl Size	7 Quart	12 Quart	20 Quart	20 Quart
HP	1/3 HP	1/2 HP	0.50 HP	0.50 HP
Belt / Gear Driven	Gear Driven	Gear Driven	Gear Driven	Gear Driven
Timer	30 Minute Digital Timer	30 Minute Digital Timer	30 Minute Digital Timer	15 Minute Digital Timer
Speeds	5	3	3	3
Electrical	110V / 6A / 650W 60Hz / 1Ph 5-15P Plug	110V / 8A / 375W 60Hz / 1Ph 5-15P Plug	110V / 8A / 375W 60Hz / 1Ph 5-15P Plug	110V / 8A / 375W 60Hz / 1Ph 5-15P Plug
Hub Size	N/A	N/A	#12*	#12*
Dims. (WDH)	18.1" x 13.4" x 20.5"	19" x 14.5" x 25.5"	21.4" x 22.7" x 30.6"	20" x 23" x 33"
Net Weight	40 lbs.	77 lbs.	124.6 lbs.	216 lbs.
Shipping (WDH)	20" x 15" x 24"	22" x 20" x 26"	29" x 25" x 40"	21" x 25" x 40"
Shipping Weight	44 lbs.	80 lbs.	150 lbs.	276 lbs.
Warranty	1-Year Limited	1-Year Limited	2-Year Limited	2-Year Limited

All BakeMax Planetary Mixers include a Wire Whip, Flat Beater & Hook.

*#12 Hub can use the BMVS001 Vegetable & Cheese Slicer or BMMGA01 Meat Grinder Hub Attachments

Think Quality - Think Value - Think Service - Think BakeMax



Bakery & Pizza Equipment

Planetary Mixers

The BakeMax BMPM Series of Countertop Heavy Duty Planetary Mixers offers a space saving solution for cafes, restaurants, and bakeries tight on space. Our mixers provide durability, long life, and excellent mixing performance. They are safe, easy to use and capable of a broad range of dough and food mixing applications.



Model	BMPME20	BMPME30	BMPM030	BMPM040
Bowl Size	20 Quart	30 Quart	30 Quart	40 Quart
HP	1 HP	1.5 HP	1 HP	1.5 HP
Belt / Gear Driven	Gear Driven	Gear Driven	Gear Driven	Gear Driven
Timer	N/A	N/A	15 Minutes - Manual	15 Minutes - Manual
Speeds	3	3	3	3
Electrical	110v / 7A / 750W 60Hz / 1Ph / Nema 5-15P Plug	110V / 10A / 1100W 60Hz / 1Ph / Nema 5-15P Plug	110V / 16A / 1760w 60Hz / 1Ph / Nema 5-20P Plug	220V / 12A / 1125W 60Hz / 1Ph Hard Wired
Hub Size	N/A	N/A	#12*	#12*
Dimensions (WDH)	17" x 20" x 31"	20" x 23" x 33"	22" x 25" x 44"	26" x 28" x 49"
Net Weight	114 lbs.	139 lbs.	407 lbs.	451 lbs.
Shipping (WDH)	22" x 25" x 38"	24" x 22" x 40"	24" x 28" x 51"	28" x 32" x 57"
Shipping Weight	151lbs.	183 lbs.	476 lbs.	540 lbs.
Warranty	1-Year Limited	1-Year Limited	2-Year Limited	2-Year Limited

All BakeMax Planetary Mixers include a Wire Whip, Flat Beater & Hook.

*#12 Hub can use the BMVS001 Vegetable & Cheese Slicer or BMMGA01 Meat Grinder Hub Attachments
 Due to continuous product improvement, specifications are subject to change without notice.

Visit www.BakeMax.com for up-to-date product information.

1-800-565-2253

OrderDesk@BakeMax.com

Bakery & Pizza Equipment

Planetary Mixers



Model# BMPM60B



Model# BMPM060



Model# BMPM080



Model# BMPM120



Intertek

Intertek

Model	BMPM60B	BMPM060	BMPM080	BMPM120
Bowl Size	60 Quart	60 Quart	80 Quart	120 Quart
HP	2 HP	3 HP	4 HP	5 HP
Belt / Gear Driven	Belt Driven	Gear Driven	Belt Driven	Belt Driven
Timer	15 Minutes - Manual	15 Minutes - Manual	30 Minutes - Manual	30 Minutes - Manual
Speeds	3	4	4	4
Bowl Lift	Flywheel	Electric	Electric	Electric
Electrical	220V / 24A / 1500W 60Hz / 1Ph / Hard Wired	220V / 24A 2500W / 60Hz 1Ph / Hard Wired	220V / 18A 3000W / 60Hz / 3 Ph / Hard Wired	220V / 20A 3600W/ 60Hz / 3Ph / Hard Wired
Hub Size	#12*	#12*	#12*	#12*
Dimensions (WDH)	28" x 41" x 53"	28" x 41" x 57"	28" x 41" x 57"	33.1" x 47.24" x 65"
Net Weight	880 lbs.	1003 lbs.	1276 lbs.	1760 lbs.
Shipping (WDH)	31" x 45" x 62" H	31" x 45" x 66" H	33" x 49" x 67"	28" x 32" x 57"
Shipping Weight	1030 lbs.	1146 lbs.	1478 lbs.	2060 lbs.
Warranty	2-Year Limited	2-Year Limited	2-Year Limited	2-Year Limited

All BakeMax Planetary Mixers include a Wire Whip, Flat Beater & Hook.

*#12 Hub can use the BMVS001 Vegetable & Cheese Slicer or BMMGA01 Meat Grinder Hub Attachments
Bowl Dolly is Included on BMPM060, BMPM60B, BMPM080, and BMPM120 Models

Think Quality - Think Value - Think Service - Think BakeMax



Planetary Mixer Capacity Chart



Warehouses:

20 Caribou St, Moncton, NB E1H 0P3 
 5705 Valley Belt Rd, Independence, OH 44131 
 1201 E 27th Terrace, Pittsburg, KS 66762 

Mixing Dough & Capacity Information

The moisture content of heavy dough is a critical factor when selecting proper mixing speed. You should never use 2nd speed when mixing heavy dough with an Absorption Ratio (AR) of 50% or less. To determine the Absorption Ratio (AR) of a product, divide the water weight by the flour weight.

Example: Calculate the Absorption Ratio of a mixture containing 10 lbs. of flour and 5 lbs. of water.
 $5 / 10 = 0.50 = 50\% = \text{AR}$

PRODUCT	TOOL	BMPM007	BMPM012	BMPM020 / BMPM20A	BMPM030	BMPM040	BMPM060	BMPM080	BMPM120
Egg Whites	Whip	0.4 qts.	0.63 qts.	1 qts.	1.5 qts.	2 qts.	3.1 qts.	4.2 qts.	3.6 qts.
Mashed Potatoes	Beater	4 lbs.	10 lbs.	15 lbs.	22 lbs.	29 lbs.	40 lbs.	60 lbs.	90 lbs.
Mayonnaise (qts. Oil)	Beater	3 qts.	4 qts.	8.5 qts.	12.7 qts.	13.7 qts.	19 qts.	31.7 qts.	40 qts.
Meringue (qts. Water)	Whip	0.25 qts	0.42 qts.	0.75 qts.	1 qts.	1.5 qts.	2 qts.	3 qts.	4 qts.
Waffle/Pan cake Batter	Beater	3 qts.	4.5 qts.	7.5 qts.	12 qts.	16 qts	23 qts	32 qts.	NA
Whipped Cream	Whip	1.8 qts.	2 qts.	4 qts.	6 qts.	9 qts	12 qts	16 qts.	25 qts.
Cup Cake / Layer Cake	Beater	6 lbs.	11 lbs.	20 lbs.	30 lbs.	44 lbs.	60 lbs.	88 lbs.	120 lbs.
Sponge Cake (w/ Flour & Butter)	Whip	4 lbs.	7.5 lbs.	13 lbs.	22 lbs.	26.5 lbs.	44 lbs.	80 lbs.	120 lbs.
Sugar Cookie	Beater	3 lbs.	10 lbs.	14 lbs.	22 lbs.	30 lbs.	40 lbs.	60 lbs.	80 lbs.
Bread or Roll Dough (Light/ Medium, 60% AR)	Hook	3 lbs.*	4.4 lbs. of Flour*	10 lbs. of Flour*	16.5 lbs. of Flour*	30 lbs. of Flour**	55 lbs. of Flour**	77 lbs. of Flour**	160 lbs. of Dough Total**
Bread or Roll Dough (Heavy, 55% AR)	Hook	2 lbs.*	3.75 lbs. of Flour*	8 lbs. of Flour*	14.5 lbs. of Flour*	24.5 lbs. of Flour**	49 lbs. of Flour**	66 lbs. of Flour**	120 lbs. of Dough Total**
Thin Pizza Dough, Pasta, Basic Egg Noodle (40% AR, Max 5 Minutes of Mixing Time)	Hook	2 lbs.*	3.3 lbs. of Flour*	6.5 lbs. of Flour*	13.5 lbs. of Flour*	22 lbs. of Flour*	44 lbs. of Flour*	55 lbs. of Flour*	80 lbs. of Dough Total*
Medium Pizza Dough (50% AR)	Hook	2.5 lbs.*	3.3 lbs. of Flour*	6.5 lbs. of Flour*	13.5 lbs. of Flour*	22 lbs. of Flour*	44 lbs. of Flour*	55 lbs. of Flour*	90 lbs. of Dough Total*
Thick Pizza Dough (60% AR)	Hook	3 lbs.*	4.4 lbs. of Flour*	10 lbs. of Flour*	16.5 lbs. of Flour*	30 lbs. of Flour**	55 lbs. of Flour**	77 lbs. of Flour**	100 lbs. of Dough Total**
Raised Donut Dough (65% AR)	Hook	2.5 lbs.*	3.3 lbs. of Flour*	6.5 lbs. of Flour*	13.5 lbs. of Flour*	22 lbs. of Flour*	44 lbs. of Flour*	55 lbs. of Flour*	70 lbs. of Dough Total*
Whole Wheat Dough (70% AR)	Hook	3 lbs.*	4.4 lbs. of Flour*	10 lbs. of Flour*	16.5 lbs. of Flour*	30 lbs. of Flour**	55 lbs. of Flour**	77 lbs. of Flour**	120 lbs. of Dough Total**

Speeds:

- **1st Speed Only
- ***1st Speed & 2nd Speed Only

Notes:

- *If using high gluten or rice flour, please reduce capacity by 10%.
- *If using water colder than 70 F, ice or chilled flour, please reduce capacity by 10%.
- *Attachment hub should not be used while mixing.
- *Mixer should be powered off when changing speeds

Capacity Conversion

- *1 Gallon of Water Weighs 8.33 lbs.
- *1 Liter of Water Weighs 1 kg or 2.2 lbs.
- *1 lb = 0.454 kg / 1 kg = 2.2 lbs.
- *1 US Liquid Quart = 0.946 Liters

This chart should be used as a guide only. Type of flour and other factors can vary and may require batch size to be adjusted.

Due to continuous product improvement, specifications are subject to change without notice.

Visit www.BakeMax.com for up-to-date product information.

1-800-565-2253

OrderDesk@BakeMax.com

Bakery & Pizza Equipment

Spiral Mixers

The BakeMax BMSM Series Spiral Mixers are designed for mixing heavy dough, such as those used in Bakeries, Pizzerias or Pastry Shops. Their long-lasting stainless-steel bowls can handle 20 – 120kg of dough, depending on model.



Model	Flour Kg/lbs.	Dough Kg/lbs.	Bowl Size	Volts	Phase	Amps	Watts	HZ	Nema Code
BMSM020	11/24	20/44	36Qt.	220	3	7.5	1650	60	Hard Wired
BMSM030	15/33	30/66	53Qt.	220	3	10	2200	60	Hard Wired
BMSM040	25/55	40/88	73Qt.	220	3	12	2640	60	Hard Wired
BMSM050	30/66	50/110	84Qt.	220	3	15	3300	60	Hard Wired
BMSM070	40/88	70/154	105Qt.	220	3	17	3740	60	Hard Wired
BMSM080	50/110	80/176	127Qt.	220	3	23	5060	60	Hard Wired
BMSM120	80/176	120/264	190Qt.	220	3	35	7700	60	Hard Wired

Shipping Information

Model	Net Weight	Crated Weight	Crated Dimensions (D x W x H)
BMSM020	328lbs. / 149kg	370lbs. / 168kg	27" x 36" x 46"
BMSM030	405lbs. / 184kg	507lbs. / 204kg	28" x 42" x 48"
BMSM040	606lbs. / 204kg	714lbs. / 285kg	28" x 42" x 50"
BMSM050	661lbs. / 409kg	782lbs. / 479kg	28" x 48" x 54"
BMSM060	990lbs. / 449kg	1147lbs. / 520kg	30" x 49" x 55"
BMSM080	1190lbs. / 520kg	1345lbs. / 610kg	34" x 51" x 59"
BMSM120	2061lbs. / 935kg	2290lbs. / 1039kg	42" x 67" x 68"



*When mixing bagel dough and other stiffer doughs, you will need to reduce your capacity by 30%

Think Quality - Think Value - Think Service - Think BakeMax



Bakery & Pizza Equipment

Spiral Mixers

The BakeMax BMSM BakeMax BMSM160-320 KG Series Spiral Mixer Series Spiral Mixer is designed for mixing heavy dough, such as those used in Bakeries, Pizzerias or Pastry Shops. Their long-lasting stainless-steel bowls can handle 160-320 KG of dough, depending on model.



Model	Flour kg/lbs.	Dough kg/lbs.	Bowl Size	Volts	Phase	Amps	Spiral Arm / Bowl Motor	HZ	Nema Code
BMSM160	100/220	160/352	222 Qt	220	3	27	10 HP / 2 HP	60	Hard Wired
BMSM200	125/275	200/440	282 Qt	220	3	33.75	12 HP / 3 HP	60	Hard Wired
BMSM240	150/330	240/529	285 Qt	220	3	40.5	15 HP / 3 HP	60	Hard Wired
BMSM280	175/385	280/617	353 Qt	220	3	40.5	15 HP / 3 HP	60	Hard Wired
BMSM320	200/440	320/705	400 Qt	220	3	42.75	16 HP / 3 HP	60	Hard Wired

Shipping Information

Model	Net Weight	Crated Weight	Crated Dimensions (D x W x H)
BMSM160	1,874 lbs. / 850 kg	2,161 lbs. / 980 kg	65" x 42" x 67"
BMSM200	2,028 lbs. / 920 kg	2,315 lbs. / 1,050 kg	70" x 46" x 67"
BMSM240	2,094 lbs. / 950 kg	2,425 lbs. / 1,100 kg	71" x 52" x 68"
BMSM280	2,425 lbs. / 1100 kg	2,778 lbs. / 1,260 kg	73" x 53" x 68"
BMSM320	2,440 lbs. / 1200 kg	3,031 lbs. / 1,370 kg	74" x 55" x 70"



*When mixing bagel dough and other stiffer doughs, you will need to reduce your capacity by 30%

Due to continuous product improvement, specifications are subject to change without notice.

Visit www.BakeMax.com for up-to-date product information.

1-800-565-2253

OrderDesk@BakeMax.com

Bakery & Pizza Equipment

Spiral Mixers with Removeable Bowls

The BakeMax BMRS 120-320 KG Series Spiral Mixer with Removable Bowl is designed for mixing heavy dough, such as those used in Bakeries, Pizzerias or Pastry Shops. Their long-lasting stainless-steel bowls can handle 120-320 KG of dough, depending on model.



Model	Flour kg/lb.	Dough kg/lbs.	Bowl Size	Volts	Phase	Amps	Spiral Arm / Bowl Motor	HZ	Nema Code
BMRS120	75/165	120/265	265 Qt	220	3	30	10 HP & 2 / 1	60	Hard Wired
BMRS160	100/220	160/352	264 Qt	220	3	30	10 HP & 2 / 1	60	Hard Wired
BMRS200	125/275	200/440	305 Qt	220	3	34	12 HP & 2 / 1	60	Hard Wired
BMRS240	150/330	240/529	330 Qt	220	3	34	12 HP & 2 / 1	60	Hard Wired
BMRS280	175/385	280/617	390 Qt	220	3	41	15 HP & 2 / 1	60	Hard Wired
BMRS320	200/440	320/705	430 Qt	220	3	41	15 HP & 2 / 1	60	Hard Wired

Shipping Information

Model	Net Weight	Crated Weight	Crated Dimensions (D x W x H)
BMRS120	2,646 lbs. / 1,200 kg	2,866 lbs. / 1,300 kg	83" x 43" x 64"
BMRS160	2,756 lbs. / 1,250 kg	3,087 lbs. / 1,400 kg	85" x 46" x 67"
BMRS200	3,086 lbs. / 1,400 kg	3,351 lbs. / 1,520 kg	86" x 52" x 68"
BMRS240	3,218 lbs. / 1,460 kg	3,682 lbs. / 1,670 kg	89" x 52" x 70"
BMRS280	3,307 lbs. / 1,500 kg	3,792 lbs. / 1,720 kg	91" x 53" x 70"
BMRS320	3,527 lbs. / 1,600 kg	3,925 lbs. / 1,780 kg	92" x 54" x 71"



*When mixing bagel dough and other stiffer doughs, you will need to reduce your capacity by 30%

Think Quality - Think Value - Think Service - Think BakeMax



Bakery & Pizza Equipment

Planetary Mixers vs Spiral Mixers

It is very important to fully review your needs when choosing a mixer, as choosing the wrong style or size can slow down the operation of your business. Each mixer has its pros and cons depending on the needs of your application. Here is a list of the main features and benefits of Planetary Mixers vs Spiral Mixers.



Planetary Mixers

All Purpose Mixer used for whipping, mixing, or beating a wide variety of products.

Multiple Speed Settings to accommodate different ingredients - Eggs, Cake Batter, Potatoes, Dough, etc.

Size Options: Available in Countertop and Floor Models.

Bowl Size is measured in Quarts. We have 7Qt, 12Qt, 20Qt, 30Qt, 40Qt, 60Qt, 80Qt and 120Qt Planetary Mixers.

Accessories: These units generally come with an attachment hub to add on accessories like meat grinders and vegetable attachments

Capacity: If you plan to use the mixers maximum capacity, please refer to the capacity chart that is provided with the mixer.

Great for Restaurants, Bakeries, Cafes, Hotels and more.



Spiral Mixers

Dough Mixer, great for all kinds of varieties of dough. Pizza, Bagel, Bread, etc.

Mixer Size is generally by Flour or Dough weight.

2 Speed Setting, which is great for developing your dough.

First Speed helps bring the mix together into a consistent mass

Second Speed develops the gluten structure of the dough.

Accessories: These mixers come with a dough hook and attached bowl. Some models come with a removeable bowl.

Limitations: These mixers are only meant for dough and do not come with an accessory hub for attachments.

Great for Bakeries & Pizza Shops.

Due to continuous product improvement, specifications are subject to change without notice.

Visit www.BakeMax.com for up-to-date product information.

1-800-565-2253

OrderDesk@BakeMax.com

Bakery & Pizza Equipment

Countertop Single Pass Sheeters

The BakeMax BMEPS Series Single Pass Dough Sheeter is designed to be compact and to make efficient use of countertop space. Features two adjustable, durable, nonstick, synthetic rollers. The body is constructed of heavy-duty stainless steel, including roller shaft for extra durability and ease of cleaning. Includes 1 set of adjustable non-stick rollers. Rolling thickness 0 - 4.76 mm and roller guard to meet safety standards. Great for Pizza dough, Pie crust and Pasta.



BMEPS12

- Can Sheet Dough between 3.94" and 11.81" in Diameter
- Dough Weight: 50g – 700g
- Exterior Dimensions (WDH): 16.5" x 16.5" x 14.6"
- 110V / 9.5A / 370W / 60Hz / 1Ph
- Plug & Go 5-15P Plug
- Net Weight 44 lbs.
- Shipping Dimensions (WDH): 21" x 21" x 21"
- Shipping Weight 49 lbs.
- 1-Year Limited Warranty



BMEPS16

- Can Sheet Dough between 3.94" and 15.75" in Diameter
- Dough Weight: 50g – 1000g
- Exterior Dimensions (WDH): 20.5" x 16.5" x 14.6"
- 110V / 9.5A / 370W / 60Hz / 1Ph
- Plug & Go 5-15P Nema Plug
- Net Weight 55 lbs.
- Shipping Dimensions (WDH): 24" x 21" x 21"
- Shipping Weight 60 lbs.
- 1-Year Limited Warranty



Optional Accessory

Foot Control Pedal for

BMEPS12, BMEPS16 and BMTPS16

Think Quality - Think Value - Think Service - Think BakeMax



Bakery & Pizza Equipment

Countertop Double Pass Sheeters

The BakeMax BMTPS16 Double Pass 15.75" Dough Sheeter is an efficient two stage machine featuring a front infeed and discharge. Sheets up to 15.75" diameter dough. One operator can make up to 400 pieces per hour. The is body constructed of heavy-duty stainless steel, including roller shaft for extra durability and ease of cleaning. Includes 2 sets of adjustable non-stick rollers and digital controls for ease of use.



Features:

- Can sheet dough between 3.94" and 15.75" in diameter
- Dough Weight from 50g to 1000g
- Adjustable Thickness from 0mm to 4.76mm
- One Single Operator Can Make 400 Pieces Per Hour
- Great for Pizza dough, Pie crust and Pasta
- Exterior Dimensions (WDH): 21.5" x 21" x 31.5"
- 110V / 7.7A / 370W / 60Hz / 1Ph
- Plug & Go 5-15P Plug
- Net Weight 88 lbs.
- Shipping Dimensions (WDH): 25" x 22" x 36"
- Shipping Weight 98 lbs.
- 1-Year Limited Warranty

The BakeMax BMPS001 Heavy Duty Double Pass 20" Dough Sheeter is an efficient two stage machine featuring a front infeed and discharge. Ergonomic design makes it easy and simple to operate. Its powerful 1HP motor can sheet up to 600 pieces / hr. and is great for Pizza, Dessert Pie Crusts, Pasta, Focaccia, Roti, Calzones, Flour Tortillas and Pita Bread.

Features:

- Heavy Duty Design with Flow-Through Sheeting and Automatic Outfeed Belt
- All-In-Front Ergonomic Design saves on Labor and Space
- Heat-Treated Steel Alloy Gear Mechanism
- Adjustable Handle Controls Output Thickness
- Rolling thickness 0.04"- 0.8" (Capable of 1-20 mm)
- 4 Rollers - 2 Pass Action Front Feed, Sheet up to 20" Wide
- Exterior Dimensions (WDH): 27.6" x 32.7" x 32.7"
- Net Weight 298 lbs.
- 110V / 10.4A / 1.5HP / 60Hz / 1Ph
- Plug & Go 5-15P Plug
- Crated Dimensions (WDH): 37" x 33" x 37"
- Crated Weight 398 lbs.
- 1-Year Limited Warranty



Due to continuous product improvement, specifications are subject to change without notice.

Visit www.BakeMax.com for up-to-date product information.

1-800-565-2253

OrderDesk@BakeMax.com

Bakery & Pizza Equipment

Countertop Reversible Sheeters

The BakeMax BMCRS Series Countertop Reversible Sheeters are perfect for Bakeries, Pastry Shops, Hotels, Restaurants and more. They are suitable for sheeting and stretching Puff Pastry, Danish Bread, Fondant, Donut Dough, Croissants, Pie Crusts, Cookie Dough, Strudel, Marzipan, and Pizza Dough.



Features:

- Constructed of Heavy-Duty Steel for extra Durability and Longevity
- Safety Guards with Automatic Shut-Off when Lifted
- Easy-To-Use Forward & Reverse Controls
- Adjustable Thickness between 3-30mm
- Overload Protection prevents motor from damage
- Sides Easily fold up to save room when not in use
- Stainless Steel Rollers
- Heavy Duty Non-Stick Scrapers to help prevent Dough from Sticking to the Rollers
- Synchronized Infeed & Outfeed
- Catch Pans located on each end of the sheeter
- BMCRS01 Belt Dimensions: 17" W x 67" L
- BMCRS01 Roller Size: 3.5" x 17.7"
- BMCRS02 Belt Dimensions: 20.5" W x 67" L
- BMCRS02 Roller Size: 3.5" x 20.5"
- Plug & Go Nema 5-15P Plug
- 1-Year Limited Warranty

BMCRS02 Technical Specifications:

- Exterior Dimensions (WDH): 71" x 36" x 24"
- 110v / 7.8A / 0.5HP / 60Hz / 1Ph*
- Plug & Go Nema 5-15P Plug
- Net Weight 274 lbs.

BMCRS02 Shipping Specifications:

- Crated Dimensions (WDH): 32" x 42" x 39"
- Weight 376 lbs.

* Available in 220V by Special order (3.9A / Nema 6-15P)

BMCRS01 Technical Specifications:

- Exterior Dimensions (WDH): 71" x 32" x 24"
- 110V / 7.8A / 0.5 HP / 60Hz / 1Ph*
- Plug & Go Nema 5-15P Plug
- Net Weight 260 lbs.

BMCRS01 Shipping Specifications:

- Crated Dimensions (WDH): 32" x 38" x 39"
- Weight 363 lbs.



Think Quality - Think Value - Think Service - Think BakeMax



Bakery & Pizza Equipment

Floor Model Reversible Sheeters

The BakeMax BMFRS Series Floor Model Reversible Sheeters are perfect for Bakeries, Pastry Shops, Hotels, Restaurants and more. They are suitable for sheeting and stretching Puff Pastry, Danish Bread, Fondant, Donut Dough, Croissants, Pie Crusts, Cookie Dough, Strudel, Marzipan, and Pizza Dough.



Features:

- Constructed of Heavy-Duty Steel for Extra Durability and Longevity
- Safety Guards which automatically shuts off power to the unit when either guard is lifted up
- Easy-To-Use Controls
- Adjustable Thickness between 3-30mm
- Overload Protection
- Sides Fold up to Save Room when not in use
- Stainless-Steel Rollers
- Heavy Duty Non-Stick Scrapers to prevent Dough from Sticking to the Rollers
- Synchronized Infeed & Outfeed
- 1-Year Limited Warranty

Model	Exterior Dimensions (WDH)	Electrical	Net Weight
BMFRS01	32" x 83" x 44"	220v / 1Ph / 7.8A 60HZ / 1HP / 6-15P	344 lbs.
BMFRS02	36" x 83" x 44"	220v / 1Ph / 7.8A 60HZ / 1HP / 6-15P	388 lbs.
BMFRS03	40" x 99" x 44"	220v / 1Ph / 7.8A 60HZ / 1HP / 6-15P	476 lbs.

Model	Belt Dimensions	Roller Size
BMFRS01	17" Width x 79" Length	3.5" x 17.7"
BMFRS02	20.5" Width x 79" Length	3.5" x 20.5"
BMFRS03	25" Width x 95" Length	3.5" x 25.6"

Shipping Specifications

Model	Crated Dimensions (WDH)	Shipping Weight
BMFRS01	38" x 32" x 75"	502 lbs.
BMFRS02	42" x 32" x 75"	546 lbs.
BMFRS03	48" x 32" x 82"	660 lbs.



Due to continuous product improvement, specifications are subject to change without notice.

Visit www.BakeMax.com for up-to-date product information.

1-800-565-2253

OrderDesk@BakeMax.com

Bakery & Pizza Equipment

Dough Molders

The BakeMax BMMDM01 Mini Dough Molder is perfect to produce artisan bread, pretzels, sweet breads, knotted dinner rolls and much more. This moulder will consistently produce uniform bread loaves ranging from 30 – 280 grams / 1.05 – 9.88 oz and can produce up to 2000 pcs / hour.



Features:

- Heavy-Duty Construction for Durability and Longevity
- Suitable for all kinds of Artisan Breads, Pretzels, Sweet Breads, Knotted Dinner Rolls and much more.
- Consistently Produces Uniform Bread Loaves Ranging from 30 – 280 grams (1.05 – 9.88 oz)
- Belt Width: 11.8"
- Easy Single Person Operation
- Does Not Require any Molding Plates
- Movable Flour Box to Prevent Dough from Sticking
- Hinged-Cover for Easy Cleaning and Maintenance
- Exterior Dimensions (WDH): 54" x 27" x 43"
- 110V / 15A / 750W / 60Hz / 1Ph / Hard Wired
- Net Weight: 440 lbs.
- Crated Dimensions (WDH): 57" x 38" x 48"
- Shipping Weight: 617 lbs.
- 1-Year Limited Warranty



The BakeMax BMFBM01 French Bread Molder is perfect to produce baguettes, finger rollers, long-loaves, petit pans, hot dog buns and various other sized breads. The BMFBM01 sheets through a series of three rollers and the progressive extension of the loaf is accomplished between two conveyor belts running in the opposite direction at varying speeds. This allows for gentle dough handling and a "hand-made" effect. This moulder will consistently produce uniform bread loaves ranging from 50 – 1250 grams / 1.76 – 44 oz and can produce up to 1200 pcs / hour.

Features:

- Suitable for all kinds of Bread; including Sub Rolls, Hot Dog Buns, and French Bread
- Consistently Produces Uniform Bread Loaves Every Time
- Mounted on a Stand with Locking Casters
- Adjustable Indicator of Molding Thickness is easily and Accurately Controlled
- Safety Overload Protection
- Exterior Dimensions (WDH): 39" x 35" x 61"
- 220V / 7A / 750W / 60Hz / 3Ph / Hard Wired
- Product Weight: 505 lbs.
- Crated Dimensions (WDH): 50"x35"x 41"
- Shipping Weight: 720 lbs.
- 1-Year Limited Warranty



Think Quality - Think Value - Think Service - Think BakeMax



Bakery & Pizza Equipment

Hand Bun Dividers

The BakeMax BMHBD01 Hand Bun Divider manually divides dough into 36 equal dough portions. Size of dough portions approximately 1oz - 4oz. Great for pizzerias, bakeries, and cafes.



Features:

- Saves Time and Labor by Effortlessly Dividing Dough into 36 Equal Portions
- Space Saving Design
- Dough Weights from 1oz up to 4oz
- Includes Plastic Dividing Pan
- Can be used with a variety of dough including yeast raised, cookie, pie and even ground meat/sausage for exact portion control
- Exterior Dimensions (WDH) 15" x 20" x 24" (With pressure handle down)
- Net Weight 144 lbs.
- Packaged Dimensions (WDH) 17" x 21" x 29"
- Packaged Weight 176 lbs.
- 1-Year Limited Warranty

*Available with Stainless-Steel Dividing Pan



The BakeMax America BAHBD02 Hand Bun Divider divides dough into 30 equal dough balls. Size of dough balls approximately 1oz to 2.3oz. Comes mounted on stand.

Features:

- Helps to save time and labor
- Manually Divides Dough into 30 Equal Dough Balls
- Dough Balls Approximately 1oz – 2.3oz
- Comes Mounted on Table
- Includes Stainless Steel Molding Pan
Moulder Dimensions 14.5" wide x 18.5" deep with the lever up (25" deep with the lever down) x 23" high with the lever down (39.5" high with the lever up).
- Exterior Dimensions (WDH) 15.2" x 24" x 33"
- Net Weight 97 lbs.
- Packaged Dimensions (WDH) 19" x 32" x 57"
- Shipping Weight 141 lbs.
- 1-Year Limited Warranty



Due to continuous product improvement, specifications are subject to change without notice.

Visit www.BakeMax.com for up-to-date product information.

1-800-565-2253

OrderDesk@BakeMax.com

Bakery & Pizza Equipment

Hand Bun Dividers

The BakeMax BMDM Series Manual Dough Dividers are simple to operate and extremely accurate. These Dough Dividers will divide a single large piece of dough into 36, 18, or 9 equal pieces. With the base unit, dough may be divided into pieces small enough for mini-buns, hamburger or hot dog buns, dinner rolls, all the way up to pieces weighing enough to produce sub rolls, hoagies, pita, pizzas and more.



- Each unit comes with one of the 9-part (Model#BMDMIH09), 18-part (Model#BMDMIH18) or 36-part (Model#BMDMIH36) dividing head assemblies.
- 36 & 18 Division Dividing Heads – Model # BMDMIH36/18
- 36 & 9 Division Dividing Heads – Model # BMDMIH36/9
- 18 & 9 Division Dividing Heads – Model # BMDMIH18/9
- 36,18 & 9 Division Dividing Heads – Model # BMDMIH36/18/9
- Patented removability feature, no tools required to change or remove the head assembly
- White Powder Coat Finish can be totally cleaned in minutes, removable head(s) can be washed in a sink or dishwasher
- Can be used with a variety of dough including yeast raised, cookie, pie and even ground meat/sausage for exact portion control.
- Product Dimensions(W x D x H): 18.5" x 14" x 41"
- Product Weight: 83lbs.
- Shipping Dimensions (W x D x H): 19.5" x 15.75" x 25.5"
- Shipping Weight: 91lbs.
- White Powder Coated
- No Electricity Required
- 2-Year Warranty



The BakeMax BMDMSQ09 Hand Bun Divider divides dough into 9 equal square dough portions.

- Size of dough portions approximately 5oz to 23oz.
- Interchangeable/Removable head assembly in 9-part square divisions allows fast accurate scaling of individual 4" x 4" pieces
- Capable of dividing many types of dough including Yeast Raised, Cookie, Pie & more.
- Excellent for Pizza and Bread Production
- Make Square Ciabatta Rolls.
- Simple to operate - learn in just minutes!



Think Quality - Think Value - Think Service - Think BakeMax



Bakery & Pizza Equipment

Semi-Automatic Bun Divider Rounder

The BakeMax BMBD Series Semi-Automatic Dough Divider Rounder offers superior rounding, durability and increased production for Bakeries, Pizzerias and Factory Operations. The machine divides and rounds dough with ease and allows you to make different types of rolls, pizza dough balls, donuts and more with varying weight ranges and sizes in the same machine.



Features:

- Heavy-Duty Construction for Durability and Longevity
- Easily Divides & Rounds up to 7.9lbs of dough into 30-36 (1.06-4.23oz) Dough Balls
- Quiet Operation with Minimal Vibration when Bolted
- Cutting Blades formed in #304 Stainless-Steel, anti-rust, sanitary, and easy to clean with its tilting head
- Divide and Round dough with ease and easily adjusts for different dough weights
- Hourly production of up to 3,500 pieces (depending on operator and workflow)
- Permanent lubrication to protect transmission
- Manual motor start with built-in thermal overload protection.
- Comes standard in single phase and is available in 3 phases by special order
- Includes 3 Molding plates
- 1-Year Limited Warranty

Technical Specifications

Model	Divider Range	Pieces	Electrical	Dimensions (WDH)	Weight
BMBD030*	1.41 - 4.23 oz / 40 - 120 g	30	220V / 10A 60HZ / 1PH	25.2" x 30.7" x 52" (81" with the lever up)	728 lbs.
BMBD036*	1.06 - 3.53 oz / 30 - 100 g	36	220V / 10A 60HZ / 1PH	25.2" x 30.7" x 52" (81" with the lever up)	728 lbs.

*Available in 3Ph by Special order (220V / 8A)

Shipping Specifications

Model	Dimensions (WDH)	Weight
BMBD030	29" x 35" x 62"	806 lbs.
BMBD036	29" x 35" x 62"	806 lbs.

**BakeMax BMBDF36 Fully Automatic 36 Division Bun Divider Rounder (Special Order)



Due to continuous product improvement, specifications are subject to change without notice.

Visit www.BakeMax.com for up-to-date product information.

1-800-565-2253

OrderDesk@BakeMax.com

Bakery & Pizza Equipment

Semi-Automatic Bun Divider Rounder

The BakeMax BMJN001 Semi-Automatic Dough Divider Rounder offers superior rounding, durability and increased production for Bakeries, Pizzerias and Factory Operations. The machine divides and rounds dough with ease and allows you to make different types of rolls, pizza dough balls, donuts and more with varying weight ranges and sizes in the same machine.



- Interchangeable Dividing Heads give additional dividing & rounding capability up to 26 oz. each piece.
- 36 Division (Model#BMJN036) 1oz – 2.75oz Portions
- 18 Division (Model#BMJN018) – 2oz – 7oz Portions
- 9 Division (Model#BMJN009) – 7oz – 18oz Portions
- 6 Division (Model#BMJN006) – 18oz– 26oz Portions
- High production rate - up to 5,000 pieces or more per hour.
- Removable Interchangeable Head(s) can be washed in a sink or dishwasher.
- High production rate – up to 5000 pieces or more per hour
- Stainless Steel Cutting Knives and Ring
- Easy to operate - Learn in minutes - Training Video included.
- Profits can now be increased, by eliminating tedious hand scaling and rounding, with the larger division capability of 1-ounce up to 26-ounces, which the BakeMax BMJN001 Series easily produces.
- Cleaning is accomplished by simply removing, in seconds, the rounding head assembly, and washing as you would other bakery pans and utensils.
- USDA listed, which recognizes outstanding cleanability and construction features, attested to by the United States Department of Agriculture
- Includes 2 Dough Plates
- NSF, USDA & UL Listed - Made in the USA
- 2-Year Parts & Labor Warranty

Product & Shipping Specifications

- Product Dimension(W x D x H): 26.8" x 22" x 81.25"
- Product Weight: 449lbs. (202kg)
- Shipping Dimension(W x D x H): 28.25" x 25.5" x 66"
- Shipping Weight: 490lbs. (220.5kg)

Electrical Options

- 120V / 750W / 60Hz / 1Ph
- 240V / 60Hz / 750W / 1Ph
- 208V / 60Hz / 560W / 3Ph



Think Quality - Think Value - Think Service - Think BakeMax



Bakery & Pizza Equipment

Hydraulic Dough Divider

The BakeMax BMBT030 Hydraulic Dough Divider gently divides up to 16kg of dough in 20 even pieces. Simple to operate, the square chamber minimizes pressure on dough combining performance and speed. This unit is perfect for small to large scale bakeries and other food service operations.



Features:

- Effortlessly manage up to 20 pieces of dough, streamlining your production process.
- Utilizes a sophisticated hydraulic system for precise and consistent dough processing, ensuring optimal results every time.
- Designed with a focus on efficiency, the BakeMax BMBT030 minimizes downtime and maximizes productivity in your bakery operations.
- Built with a steel frame & stainless-steel cutting knives to withstand the rigors of daily commercial use, ensuring long-lasting performance.
- Ergonomic controls make it easy for operators to manage and adjust settings, promoting a user-friendly experience.
- Mounted on two locking swivel casters and two non-locking swivel casters.
- Single lever controls pressure plate and knives.
- Simple to operate and virtually maintenance free.
- The round chamber minimizes pressure on dough, combining performance, speed, and work comfort
- Dough Capacity: 3 -16 kg (6.6 - 35 lbs.)
- Dividing Weight: 150 – 800 g / pcs (5.29 – 28.22 oz)
- Number of Division: 20
- Dimensions of Dividing Chamber 100 x 100 mm (3.94” x 3.94”)
- 1-Year Limited Warranty

Technical Specifications:

- Exterior Dimensions (WDH): 25.2” x 26.2” x 47.3”
- 220V / 7A / 1500W / 60Hz / 3Ph / Hard Wired
- Net Weight 717lbs.

Shipping Specifications:

- Crated Dimensions (WDH): 30” x 30” x 53”
- Crated Weight 805lbs.



Due to continuous product improvement, specifications are subject to change without notice.

Visit www.BakeMax.com for up-to-date product information.

1-800-565-2253

OrderDesk@BakeMax.com

Bakery & Pizza Equipment

Dough Ball Rounders

The BakeMax Dough Ball Rounders can quickly round bread or pizza dough without strain. We have the Dough Rounder to suit your needs, with a rounding range from 30-1200g, our dough rounders are perfect for Bakeries and Pizza Shops. Both the BMDBR01 & BMDBR02 can work in conjunction with the BMCCD01 Continuous Dough Divider.



BMDBR01 Features:

- Portions Ranging from 1.05 - 10.6oz (30g - 300g)
- Comes with Three Interchangeable Heads
- Constructed with a 304-carbon steel with white epoxy finish.
- Includes 3 interchangeable heads for adjustable rounding ranges:
 - Small: 1.05 oz – 3.5 oz (30g - 99.2g)
 - Medium: 3.5 oz – 7 oz (99.2g – 198g)
 - Large: 7 oz – 10.6 oz (198.4g – 300g)
- Output: Up to 1,200 pcs / hour
- 1-Year Limited Warranty



BMDBR02 Features:

- Portions Ranging from 1.05 - 12.5oz (30 - 350g)
- Output ranging from 700-900 pieces per hour
- Customizable controls for stroke, rotation, and oscillation knead dough precisely for desired texture.
- Resulting dough balls exhibit enhanced proofing for quality rustic, rye, sourdough, multigrain, and specialty breads
- Ensures consistent, reliable performance with advanced technology for professionals and enthusiasts.
- Simplifies the dough molding process, catering to both seasoned professionals and beginners.
- Sturdy and durable, built with high-quality materials for long-lasting performance in commercial kitchens or bakeries
- Meticulous molding creates a unique seam, adding a touch of craftsmanship to the final product.
- 1-Year Limited Warranty



Model	Exterior Dimensions (WDH)	Net Weight	Packaged Dimensions (WDH)	Shipping Weight	Electrical	Plug
BMDBR01	25.2" x 26.2" x 47.3"	110lbs.	30" x 30" x 53"	190lbs.	110V / 8A 60Hz 1Ph	Plug & Go NEMA 5-15P
BMDBR02	29" x 26" x 20"	115lbs.	31.5" x 30.3" x 26"	176lbs.	110V / 7A 60Hz 1Ph	Plug & Go NEMA 5-15P

Think Quality - Think Value - Think Service - Think BakeMax



Bakery & Pizza Equipment

Dough Ball Rounders

The BakeMax BMDBR03 / BMDBR3L Dough Ball Rounder can quickly round bread or pizza dough without strain. Portions ranging from 70 - 1,200 grams without any need to change parts or accessories. The BMDBR03 / BMDBR3L processes each portion 50 times to ensure they come out round and perfectly closed, ready to rise, as if they were rounded manually. The BMDBR03 / BMDBR3L can produce up to 300 Kg depending on dough portions.



Features:

- Constructed of High-Quality Stainless Steel and Anodized Aluminum
- Open operation concept guarantees a continuous visual control that eliminates any possibility of mechanical jam. Allowing for an easier and more accurate cleaning.
- Saves Time and Labor with its Automaticity
- No Parts or Accessories needed to change Rounding Capacity
- Processes each portion 50 times to ensure they come out round and perfectly closed, without causing any strain to the dough.
- Rounding Range: 70 to 1,200 Grams
- Output: 40-300KG Per Hour
- 2-Year Limited Warranty

Technical Specifications:

- BMDBR03 Exterior Dimensions (WDH): 30" x 30" x 16"
- BMDBR03 Net Weight 135 lbs.
- BMDBR3L Exterior Dimensions (WDH): 30" x 30" x 42"
- BMDBR3L Net Weight 163 lbs.
- 115V / 7A / 370 W / 60Hz / 1Ph
- Nema 5-15P Plug

Shipping Specifications:

- BMDBR03 Packaged Dimensions (WDH): 31" x 31" x 32"
- BMDBR03 Packaged Weight 195 lbs.
- BMDBR3L Packaged Dimensions (WDH): 31" x 31" x 42"
- BMDBR3L Packaged Weight 219 lbs.



*Available with Legs and Casters Model# BMDBR3L

Due to continuous product improvement, specifications are subject to change without notice.

Visit www.BakeMax.com for up-to-date product information.

1-800-565-2253

OrderDesk@BakeMax.com

Bakery & Pizza Equipment

Automatic Countertop Dough Divider

The BakeMax BMCCD01 Countertop Continuous Dough Divider divides dough fast and efficiently. Comes with a 33lb dough hopper and power outfeed belt. This unit is great for pizza, bread, and other types of dough. This unit has a production output of 500-2000 pieces per hour, depending on the operator.



BMCCD01 Features:

- Constructed with 304 Stainless-Steel.
- Safety Switches on Top & Side Door to shut off power to the machine when either door is opened.
- Countertop unit can be used in conjunction with BMDBR01 or BMDBR03 Dough Ball Rounders. The conveyor belt from the BMCCD01 can feed into either dough ball rounders. (Customized worktables not included).
- Includes 4 scaling cones, offering a range of 30 - 350g (1.058oz – 12.35oz)
- Electrical: 110V / 9.5A / 1100W / 60Hz / 1Ph
- Plug & Go Nema 5-15P Plug
- Exterior Dimensions (WDH): 26" x 36" x 24" – 235lbs
- Shipping Dimensions (WDH): 27" x 43" x 36" – 288lbs
- 1-Year Limited Warranty



Automatic Countertop Dough Divider & Rounder Combo

The BakeMax Divider Rounder Combo units are composed of one dough divider and one dough rounder and are made to be completely automatic. They prepare and round and perfectly closed dough portions of different weights with ease, saving time and labor. These machines are extremely easy to disassemble and to clean. This machine is manufactured according to sanitary and safety norms. Includes a BMDBR03 Dough Ball Rounder.



BMDD003 Features:

- Constructed of High-Quality Stainless Steel
- Saves Time and Labor with its Automaticity
- New Sensor measuring technology for precision cutting
- The rounder processes each portion 50 times to ensure they come out round and perfectly closed, without causing any strain to the dough.
- Removable Dough Hopper that can hold up to 44 Liters of Dough
- Dividing Range: 70 – 250 grams. (2.5 - 8.8oz)
- Rounding Range: 70 to 1,200 grams
- Output: 70-200 kg per hour
- Exterior Dimensions (WDH): 29.1" x 35.8" x 40.2"
- Net Weight: 384lbs.
- 115v / 15A / 1120 W / 60Hz / 1Ph
- Plug & Go Nema 5-15P Plug
- Packaged Dimensions: (WDH): 32.3" x 39.4" x 47.2"
- Packaged Weight: 441lbs.
- 2-Year Limited Warranty



Think Quality - Think Value - Think Service - Think BakeMax



Bakery & Pizza Equipment

Floor Model Automatic Dough Divider Rounder Combo

BMDD005 Features:

- Constructed of High-Quality Stainless Steel
- Saves Time and Labor with its Automaticity
- New Photocell Sensor measuring technology for precision cutting
- The Dough Ball Rounder processes each portion 50 times to ensure they come out round and perfectly closed, without causing any strain to the dough.
- Dough Hopper holds up to 44 Liters of Dough
- Dividing Range: 180 – 550 grams (6.4oz – 19.4oz)
- Rounding Range: 70 – 1200 grams (2.5 – 42.3oz)
- Dough Output: 70-400 kg per hour
- Exterior Dimensions (WDH): 28.4" x 33.9" x 63.4"
- Product Weight 474lbs.
- 115V / 13A / 1300W / 60Hz / 1 Phase
- Standard Plug & Go Nema 5-15P Plug.
- Packaged Dimensions (WDH): 31.9" x 35.8" x 68.5"
- Packaged Weight 530lbs.
- 2-Year Limited Warranty



BMDD007 Features:

- Constructed of High-Quality Stainless Steel
- Saves Time and Labor with its Automaticity
- New Photocell Sensor measuring technology for precision cutting
- The Dough Ball Rounder processes each portion 50 times to ensure they come out round and perfectly closed, without causing any strain to the dough.
- Dough Hopper holds up to 44 Liters of Dough.
- Dividing Range: 260g-1100g (9.17oz - 38.8oz)
- BMDBR3L Rounding Range: 70g - 1200g
- Output: 70-400 kg per hour
- Exterior Dimensions (WDH) 28.4" x 33.9" x 63.4"
- Product Weight 485lbs.
- 115V / 13A / 1300W / 60Hz / 1 Phase
- Standard Plug & Go Nema 5-15P Plug.
- Packaged Dimensions (WDH) 32" x 35.8" x 68.5"
- Packaged Weight 540lbs.
- 2-Year Limited Warranty

Due to continuous product improvement, specifications are subject to change without notice.

Visit www.BakeMax.com for up-to-date product information.

1-800-565-2253

OrderDesk@BakeMax.com

Bakery & Pizza Equipment

Manual Pizza Presses

The BakeMax BMDM Series of Manual Pizza Presses are perfect for low to medium production volumes. It is a fast, safe, simple, mess free alternative to hand tossing or sheeting/rolling your pizza dough. Our dough presses are an easy, affordable way to improve your production time, as well as your finished product.



Model	BMDMS-18	BMDMS-2-18	BMDM-18	BMDM-18NH
Production Volume	9"-18" = 75-100/hr. 7"-9" = 150 200/hr. 6" = 300-400/hr.	9"-18" = 75-100/hr. 7"-9" = 150 200/hr. 6" = 300-400/hr.	9"-18" = 75-100/hr. 7"-9" = 150 200/hr. 6" = 300-400/hr.	9"-18" = 75-100/hr. 7"-9" = 150 200/hr. 6" = 300-400/hr.
Platens	Upper Heated	Dual-Heat	Upper Heated	No Heat
Design	Swing-away	Swing-away	Clamshell	Clamshell
Manual / Auto	Manual	Manual	Manual	Manual
Thickness Range	1/16"-7/8"	1/16"-7/8"	1/16"-7/8"	1/16"-7/8"
Temperature Range	0-400°F, 204°C	0-400°F, 204°C	0-200°F, 93°C	No heat
Electrical	120v / 10a / 1150w 60 Hz / 1 Ph / Plug & Go 5-15P	120v / 10a / 1150w 60 Hz / 1Ph / Plug & Go 5-15P	120v / 9.8a / 1150w 60 Hz / 1Ph / Plug & Go 5-15P	N/A
Dimensions (WDH)	18" x 24.5" x 20"	18" x 24.5" x 20"	18" x 28" x 31"	18" x 28" x 31"
Net Weight	140lbs.	140lbs.	92lbs.	92lbs.
Shipping (WDH)	33" x 25" x 23"	33" x 25" x 23"	20" x 35" x 24"	20" x 35" x 23"
Shipping Weight	150lbs.	150lbs.	100lbs.	100lbs.
Warranty	1 Year Parts & Labor	1 Year Parts & Labor	1 Year Parts & Labor	1 Year Parts & Labor

Think Quality - Think Value - Think Service - Think BakeMax



Bakery & Pizza Equipment

Manual Pizza Presses

The BakeMax BMDXM commercial manual pizza dough press is perfect for medium to high production volumes (100-150/hr). Its heavy-duty stainless steel construction and cam over-lock make it the top manual press in the industry. It is a fast, safe, simple, mess-free (no flour needed) alternative to hand tossing or sheeting/rolling your pizza dough, and features a swing-away design with an upper heated platen.



BMDXMW Features:

- Digital Time and Temperature Controls
- Flattens dough balls into pizzas up to 18" in diameter
- Illuminated On/Off switch
- Optional non-stick coated upper and lower platens
- Full-range thickness adjustment from paper thin to 7/8"
- Dimensions (WHD): 22" x 31" x 32"
- Weight: 171lbs.
- Available in 120V or 220V
- Available in White Powder Coat or Stainless Steel
- Temperature Range: Off-200°F, 93°C Upper Platen
- 1-Year Parts & Labor Warranty

The BakeMax BMDXP-PB-2-8 Personal Size Pizza Press is an exciting way to par bake and form the perfect 8" personal size pizza crusts using your own pizza dough. Prepare pizza crust ahead of the rush. Crusts hold for hours refrigerated and longer frozen. Xylan coated platens make dough removal and clean-up an easy task.



BMDXP-PB-2-8 Features:

- Prepare pizza crust ahead of the lunch rush
- Crusts hold for hours refrigerated and longer frozen.
- PTFE coated platens make dough removal and clean-up an easy task.
- Compact size fits anywhere.
- Electronic timer with buzzer, 0-60 seconds.
- White Powder Coated
- Preset temperature to 430°F
- Dimensions (WHD): 11.5" x 20.5" x 14.5"
- Weight: 65lbs.
- Available in 120V or 220V
- 1-Year Parts & Labor Warranty

Due to continuous product improvement, specifications are subject to change without notice.

Visit www.BakeMax.com for up-to-date product information.

1-800-565-2253

OrderDesk@BakeMax.com

Bakery & Pizza Equipment

Automatic Pizza/Tortilla Presses

The BakeMax automatic pizza presses are perfect for high production volumes. BakeMax dough presses are an easy affordable way to improve your production time as well as your finished product. Set your time, temperature, and thickness, and it will give you consistent results every time.



*Available in White Powder Coat or Stainless Steel

Model	BMDXEW	BMTXE-2-18	BMDXAW	BMTXA-2-18W
Production Volume	9"-18" = 150-200/hr. 7"-9" = 300-400/hr. 6" = 600-800/hr.	9"-18" = 150-200/hr. 7"-9" = 300-400/hr. 6" = 600-800/hr.	9"-18" = 150-200/hr. 7"-9" = 300-400/hr. 6" = 600-800/hr.	9"-18" = 150-200/hr. 7"-9" = 300-400/hr. 6" = 600-800/hr.
Platens	Dual-Heat	Dual-Heat	Dual-Heat	Dual-Heat
Design	Swing-away	Swing-away	Swing-away	Swing-away
Manual/Auto	Auto Electric	Auto Electric	Air Automatic	Air Automatic
Thickness Range	1/16"-7/8"	1/16"-7/8"	1/16"-7/8"	1/16"-7/8"
Temperature Range	Off-200°F, 93°C	Off-450°F, 232°C	Off-200°F, 93°C	Off-450°F, 232°C
Electrical	120V / 220V	220V / 60Hz / 3100W / 15A NEMA 6-20P	120V / 220V	220V / 60Hz / 3100W / 15A NEMA 6-20P
Dimensions (WDH)	18" x 25" x 25"	18" x 25" x 27"	18" x 25" x 25"	18" x 27" x 27"
Net Weight	175lbs.	217lbs.	175lbs.	217lbs.
Shipping (WDH)	23" x 30" x 34"	23" x 30" x 34"	23" x 34" x 28"	23" x 34" x 28"
Shipping Weight	225lbs.	235lbs.	225lbs.	235lbs.
Warranty	1 Year Parts & Labor	1 Year Parts & Labor	1 Year Parts & Labor	1 Year Parts & Labor

Think Quality - Think Value - Think Service - Think BakeMax



Bakery & Pizza Equipment

Manual Tortilla Presses

The BakeMax tortilla presses are perfect for high production volumes. BakeMax dough presses are an easy affordable way to improve your production time as well as your finished product. Set your time, temperature, and thickness, and it will give you consistent results every time.



Model	BMTXMW	BMTXM-15	BMTXM-20	BM-TXM-2-18
Production Volume	9"-16" = 100-150/hr. 7"-9" = 200-300/hr. 6" = 400-600/hr.	8"-15" = 75-100/hr. 7" = 150-200/hr. 6" = 300-400/hr.	9"-16" = 75-100/hr. 7"-9" = 150-200/hr. 6" = 300-400/hr.	9"-18" = 150-200/hr. 7"-9" = 300-400/hr. 6" = 600-800/hr.
Platens	Dual Heated	Dual Heated	Dual Heated	Dual Heated
Design	Swing-away	Swing-away	Clamshell	Swing-away
Manual/Auto	Manual	Manual	Manual	Manual
Thickness Range	1/16"-7/8"	1/16"-7/8"	1/16"-7/8"	1/16"-7/8"
Temperature Range	Off-450°F, 232°C	Off-400°F, 204°C	Off-450°F, 232°C	Off-450°F, 232°C
Electrical	220V / 60Hz / 3100W 15A / NEMA 6-20P	220V / 60Hz / 3100W 15A / NEMA 6-20P	220V / 60Hz / 3100W 15A / NEMA 6-20P	220V / 60Hz / 3100W 15A / NEMA 6-20P
Dimensions (WDH)	26" x 25" x 36"	16.5" x 24" x 15.25"	17" x 29" x 15"	19" x 25" x 27"
Net Weight	205lbs.	68lbs.	95lbs.	217lbs.
Shipping (WDH)	28" x 37" x 40"	23" x 28" x 29"	23" x 34" x 24"	23" x 34" x 24"
Shipping Weight	225lbs.	85lbs.	113lbs.	235lbs.
Warranty	1 Year Parts & Labor	1 Year Parts & Labor	1 Year Parts & Labor	1 Year Parts & Labor

Due to continuous product improvement, specifications are subject to change without notice.

Visit www.BakeMax.com for up-to-date product information.

1-800-565-2253

OrderDesk@BakeMax.com

Bakery & Pizza Equipment

Tortilla Warmers

Nothing entices the appetite better than the smell of fresh, hot tortillas. The BakeMax BMTXW line of tortilla warmers work alone or coupled with a BakeMax tortilla press for a complete tortilla package. After pressing the tortillas, finish them off on a tortilla warmer. Each warmer is designed to heat evenly and reach temperatures of 425°F (218°C) giving those tortillas a fresh tortilla taste and smell.



Features

- Speeds Up Production
- Reduces Labor Cost
- No Tools Necessary
- Quick Heating Elements for efficient even surface heating.
- Safety Heat Guard Rail.
- Even heating and no cold spots.
- Temperature control dial
- Heat indicator light
- Even Heating Platens
- Adjustable Legs
- Safety Rail
- 1-Year Warranty



Model	BMTXW-1620	BMTXW-2025	BMTXW-4025
Production	700/hr.	1000/hr.	2000/hr.
Size	16" x 20"	20" x 25"	40" x 25"
Manual/Auto	Manual	Manual	Manual
Temperature Range	Off-425°F	Off-425°F	Off-425°F
Electrical	120v / 60Hz / 1750w / 15.5a / NEMA 5-15p	220v / 60Hz / 3500w / 16a / NEMA 6-15p	208v / 50-60Hz / 3200w / 15.4a / NEMA 6-20p
Dimensions (WDH)	18" x 21.5" x 6.2"	23" x 27" x 6.2"	43" x 27" x 6.2"
Net Weight	50lbs.	78lbs.	155lbs.
Shipping (WDH)	23" x 28" x 15"	23" x 28" x 29"	23" x 34" x 24"
Shipping Weight	55lbs.	83lbs.	160lbs.
Warranty	1 Year Parts & Labor	1 Year Parts & Labor	1 Year Parts & Labor

Think Quality - Think Value - Think Service - Think BakeMax



Bakery Equipment

Soft Crusted Bread Slicer

The BakeMax BMGF001 Series Bread Slicer is a reliable high-quality tabletop slicer that can be used for continuous operation. Great for all types of soft crust breads and suitable Bakeries, Supermarkets, Hotels, Restaurants and more. Includes Last Loaf Pusher and Bread Bagger.



Features:

- Attractive Space Saving Countertop Design
- Gravity Feed Chute can hold Multiple Loaves at a time
- Capable of Slicing Bread up to 15" wide and 6" high
- Last Loaf Pusher keeps hands clear from Cutting Blades
- Includes a Bagging Scoop bags bread with ease
- High Quality Slicing Blades
- Six Slice Thicknesses Available
- 1-Year Limited Warranty

Available Slice Thicknesses

- Model # BMGF001 – 7/16" (35 Blades)
- Model # BMGF002 – 1/2" (29 Blades)
- Model # BMGF003 – 9/16" (25 Blades)
- Model # BMGF004 – 5/8" (23 Blades)
- Model # BMGF005 – 3/4" (19 Blades)
- Model # BMGF006 – 1" (15 Blades)



Technical Specifications:

- Exterior Dimensions (WDH): 30" x 26" x 32"
- Electrical: 120V / 190W / 60Hz / 1Ph
- Plug & Go 5-15P Plug
- Net Weight: 165 lbs.

Shipping Specifications:

- Packaged Dimensions (WDH): 31" x 27" x 34"
- Packaged Weight: 200 lbs.

Replacement Accessories:

- Blades – Part # GF001/01/027
- Blade Changing Tool – Part # GF001/BL/001
- Last Loaf Pusher – Part # GF001/WO/001
- Drive Belt – Part # GF001/01/041
- Teflon Guides – GF001/01/031

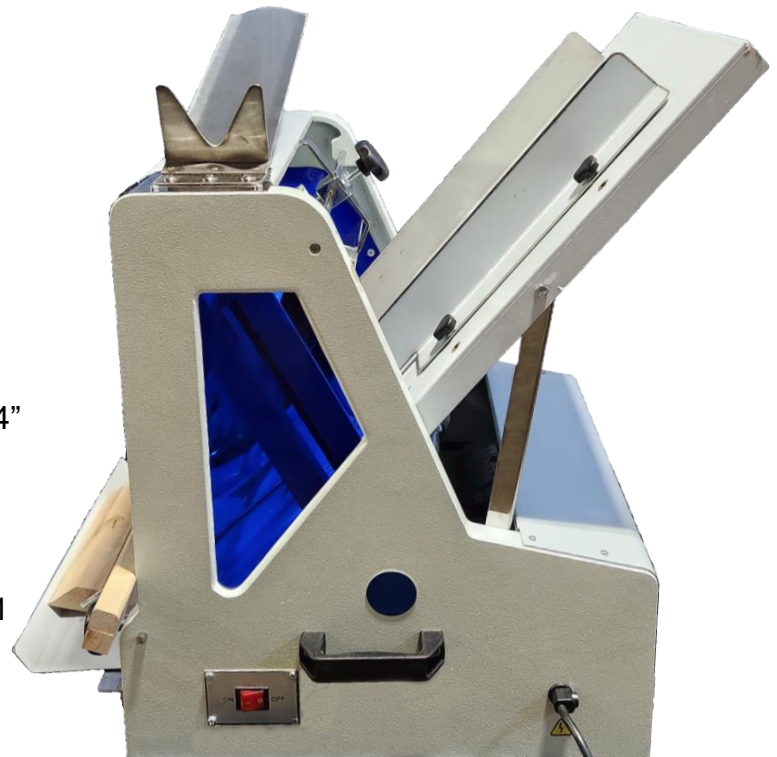

Due to continuous product improvement, specifications are subject to change without notice.

Visit www.BakeMax.com for up-to-date product information.

1-800-565-2253

OrderDesk@BakeMax.com

Bakery Equipment

Artisan Safety Bread Slicer

The BakeMax BMSS001 Artisan Safety Bread Slicer is a reliable high-quality tabletop slicer that can be used for continuous operation. While using this slicer, you are protected by an interlocked safety feeding guard which operates in conjunction with a safety loaf pusher system that is powered by a 1/2 HP motor. When the operating handle is in use the safety guard covers closely, and a safety loaf pusher passes each loaf completely through the slicer blades. A packing shelf is provided. It is recommended that the fitted crumb drawer be emptied at regular intervals to prevent mechanical failure. Great for all types of breads, but especially made for hard crust breads and suitable Bakeries, Supermarkets, Hotels, Restaurants and more. Includes last loaf pusher and bread bagger.



Features:

- Attractive Space Saving Countertop Design
- Gravity Feed Chute can hold Multiple Loaves at a time
- Slices up to 120 loaves of bread per hour regardless of manual operation time
- Powerful ½ HP Motor able to slice hard crusted breads
- Interlocked Safety Feeding Guard
- Safety Guard Closes Automatically when the operating handle is in use
- Capable of Slicing Bread up to 15" wide and 6" high
- Crumb drawer is fitted for collecting excess crumbs.
- Last Loaf Pusher keeps hands clear from cutting blades
- Includes a Bagging Scoop bags bread with ease
- High Quality Slicing Blades
- 5/8" Slicing Thickness
- 26 Premium Slicing Blades
- Meets All Quebec Safety Standards
- Electrical: 120V / 375W / 8A / 60Hz / 1Ph
- Product Weight: 253lbs.
- Crated Weight: 310lbs.
- Exterior Dimensions (DWH): 28.5" x 30" x 32.75"
- 1-Year Limited Warranty

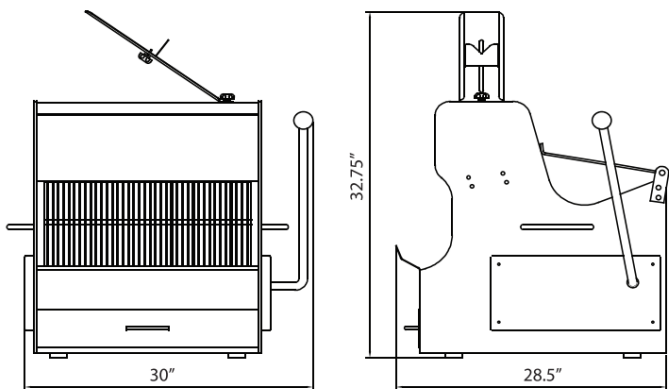

Think Quality - Think Value - Think Service - Think BakeMax



Titan Series Pizza Warmer

Titan Series Pizza Warmer

Brilliantly display your pizzas and increase impulse sales with the BakeMax BMPW418 Titan Series Pizza Warmer. Designed with a stainless-steel construction and able to hold (4) 18" Pizzas on its rotating chrome plated shelves. Keep your pizza at the ideal temperature with digital temperature and humidity controls and show it off with interior florescent lighting. This unit is great for any pizza shop or concession stand.



Features:

- Stainless-Steel Construction
- 4 Tier Rotating Chrome Plated Shelves (Holds up to (4) 18" Pizzas)
- Digital Temperature Control that ranges from 30-90°C (86-194°F)
- Adjustable Humidity Control
- Tempered Glass Door and Side Panels
- Interior LED Lighting
- Exterior Dimensions (WDH): 25.5" x 23.75" x 27.75"
- 120V / 15A / 1700W / 60Hz / 1Ph
- Plug & Go 5-15P Plug
- Net Weight 71lbs.
- Packaged Dimensions (WDH): 28" x 28" x 30"
- Packaged Weight 78lbs.
- 1-Year Limited Warranty

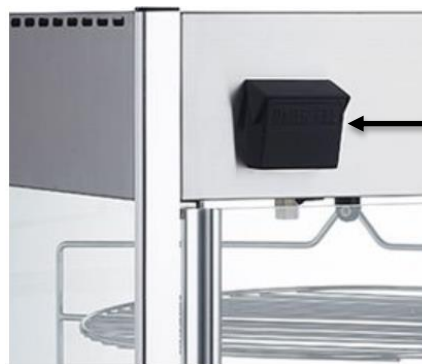

Easy Access
Water Reservoir



**BMPW418 Pizza Warmer
with Door Open**

Digital Temperature
& Humidity Controls

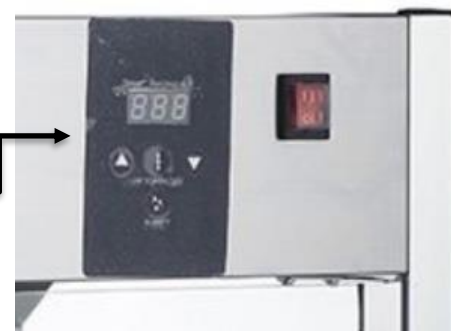

Due to continuous product improvement, specifications are subject to change without notice.

Visit www.BakeMax.com for up-to-date product information.

1-800-565-2253

OrderDesk@BakeMax.com

Water Meters

BakeMax BMW Series Water Meter



Model # BMWMS15



Connection

Model	Pipes
BMWM010	IN 3/4" F / OUT 3/4" M
BMWMS15	3/4" M

Capacity

Model	Measurement	Temperature
BMWM010	999 liters	30°C
BMWMS15	999 liters	30°C



Mixer Bowl Hose
Part # WM015/HOSE

Features:

- BMWMS15 is constructed entirely of High-Quality Stainless Steel & Automatically mixes the Hot & Cold Water to the Set Temperature
- BMWM010 is constructed of a Durable Plastic, and you must mix the hot & cold water yourself
- Saves Time and Easy to Operate
- Dispenses Precise Amount of Water to make Perfect Dough Every Time
- Capable of Displaying Temperature in Celsius and Fahrenheit.
- Digital Display Measures in Liters, Gallons, and Pounds.
- Flow Rate 100-3000 Liters/Hour
- 110V / 1A / 50/60Hz
- Plug & Go Nema 5-15P Plug
- 2-Year Limited Warranty

BMWM010 Specifications:

- Product Dimensions (WDH): 10" x 12 x 3.2"
- Shipping Dimensions (WDH): 12" x 12" x 5"
- Shipping Weight: 6 lbs.

BMWMS15 Specifications:

- Product Dimensions (WDH): 15.5" x 12" x 5"
- Shipping Dimensions (WDH): 17" x 15" x 9"
- Shipping Weight: 15 lbs.



Model # BMWM010

Think Quality - Think Value - Think Service - Think BakeMax



Cooking Equipment

Artisan Stone Deck Ovens

The BakeMax Electric Artisan Stone Deck Oven are European in design and performance. The ovens are designed for high volume baking, pizza, and all-purpose operations. Unique in both design and technology, our ovens are not only an excellent baking solution, but also offer a contemporary style serving as a centerpiece for today's high-end baking industry. Its versatility makes it suitable for a wide range of products. This modular oven is suitable for any production capacity; the number of decks can be gradually increased as your business grows. Available in pan widths ranging from one through four pans wide and up to four decks high. Optional proofers and storage cabinets available for the one, two and three pan wide ovens.



Two Pan Wide Deck Oven
with Optional Proofer



Robust Construction:

- Crafted with a durable stainless steel front exterior and a high-grade steel chamber for lasting performance.
- Fully insulated with rock wool to prevent heat loss and ensure superior efficiency.

Customizable Decks:

- Separate steel decks, providing flexibility to add or remove decks based on your business requirements.

Visibility and Appeal:

- Adjustable doors with large tempered glass windows for a clear view of cooking products, creating an attractive selling point for customers.

User-Friendly Controls:

- Power on-off rocker switch for each deck.
- Digital temperature controllers with LED display and temperature-ready indicators for precise control.

Advanced Temperature Management:

- Sensitive K-type thermocouple sensors for accurate temperature readings.
- Maximum baking temperature of 600°F

Spacious Interior:

- Accommodates 18" x 26" Full-Size Pans



Efficient Timers:

- 99-minute digital timers with LED display and continuous ring alarm, controlled by convenient rocker switches.

Illumination and Moisture Control:

- Chamber oven light controlled by rocker switches.
- Moisture control dampers for customized cooking conditions.

Crunchy Bottom Crust:

- Includes a stone hearth for a crispier bottom crust and a more golden-brown finish. The stone decks are designed to eliminate thermal expansion issues.

Smart Steam Generation:

- Compartment Steam Generator above heating elements absorbs and recycles upward heat, generating strong steam without consuming extra electric power for rapid recovery.

Optimal Heat Distribution:

- Independent, operator-controlled top and bottom heating elements ensure uniform heat distribution.
- Digital thermostats for top and bottom elements offer infinite adjustments, providing optimal thermal conditions for various baking needs.

Due to continuous product improvement, specifications are subject to change without notice.

Visit www.BakeMax.com for up-to-date product information.

1-800-565-2253

OrderDesk@BakeMax.com

Cooking Equipment

Artisan Stone Deck Ovens

Single Pan Wide Model	# of Decks	Electrical	Net Weight	Chamber Dimensions (WDH)	External Dimensions (WDH)	Crated Dimensions (WDH)	Crated Weight
BMSD001	1 Deck	220V / 3PH / 16A / 4kW / 60Hz	397 lbs.	30" x 21" x 7"	47" x 34.5" x 52"	53" x 40" x 60"	463 lbs.
BMSD002	2 Deck	220V / 3PH / 24A / 8kW / 60Hz	772 lbs.	30" x 21" x 7"	47" x 34.5" x 69.3"	53" x 40" x 76"	882 lbs.
BMSD003	3 Deck	220V / 3PH / 32A / 12kW / 60Hz	948 lbs.	30" x 21" x 7"	47" x 34.5" x 73"	53" x 40" x 80"	1125 lbs.
BMSD004	4 Deck	220V / 3PH / 40A / 16kW / 60Hz	1213 lbs.	30" x 21" x 7"	47" x 34.5" x 83"	53" x 40" x 91"	1389 lbs.
Two Pan Wide Model	# of Decks	Electrical	Net Weight	Chamber Dimensions (WDH)	External Dimensions (WDH)	Crated Dimensions (WDH)	Crated Weight
BMDDD01	1 Deck	220V / 3PH / 28A / 6kW / 60Hz	485 lbs.	38.1" x 31" x 7"	55.5" x 42.5" x 52"	62" x 48" x 60"	618 lbs.
BMDDD02	2 Deck	220V / 3PH / 42A / 12kW / 60Hz	992 lbs.	38.1" x 31" x 7"	55.5" x 42.5" x 69.3"	62" x 48" x 76"	1213 lbs.
BMDDD03	3 Deck	220V / 3PH / 55A / 18kW / 60Hz	1676 lbs.	38.1" x 31" x 7"	55.5" x 42.5" x 73"	62" x 48" x 80"	1940 lbs.
BMDDD04	4 Deck	220V / 3PH / 69A / 24kW / 60Hz	2161 lbs.	38.1" x 31" x 7"	55.5" x 42.5" x 83"	62" x 48" x 91"	2403 lbs.
Three Pan Wide Model	# of Decks	Electrical	Weight	Chamber Dimensions (WDH)	External Dimensions (WDH)	Crated Dimensions (WDH)	Crated Weight
BMTD001	1 Deck	220V / 3PH / 35A / 9kW / 60Hz	617 lbs.	57.3" x 31" x 7"	75" x 42.5" x 52"	81" x 48" x 60"	728 lbs.
BMTD002	2 Deck	220V / 3PH / 54A / 18kW / 60Hz	1433 lbs.	57.3" x 31" x 7"	75" x 42.5" x 69.3"	81" x 48" x 76"	1654 lbs.
BMTD003	3 Deck	220V / 3PH / 71A / 27kW / 60Hz	2161 lbs.	57.3" x 31" x 7"	75" x 42.5" x 73"	81" x 48" x 80"	2492 lbs.
BMTD004	4 Deck	220V / 3PH / 95A / 36kW / 60Hz	2726 lbs.	57.3" x 31" x 7"	75" x 42.5" x 83"	81" x 48" x 91"	3087 lbs.
Four Pan Wide Model	# of Decks	Electrical	Weight	Chamber Dimensions (WDH)	External Dimensions (WDH)	Crated Dimensions (WDH)	Crated Weight
BMFD001	1 Deck	220V / 3PH / 40A / 10kW / 60Hz	771 lbs.	74.6" x 31" x 7"	92" x 42.5" x 52"	98" x 48" x 60"	948 lb.
BMFD002	2 Deck	220V / 3PH / 61A / 20kW / 60Hz	1500 lbs.	74.6" x 31" x 7"	92" x 42.5" x 69.3"	98" x 48" x 76"	1720 lb.
BMFD003	3 Deck	220V / 3PH / 80A / 30kW / 60Hz	2425 lbs.	74.6" x 31" x 7"	92" x 42.5" x 73"	98" x 48" x 80"	2822 lb.
BMFD004	4 Deck	220V / 3PH / 100A / 40kW / 60Hz	3043 lbs.	74.6" x 31" x 7"	92" x 42.5" x 83"	98" x 48" x 91"	3374 lb.

Single Pan Wide Optional Accessories	Description
BMSDDP1	Proofer for Single, Double & Triple Deck Oven
BMSDDS1	Storage Cabinet for Single, Double & Triple Deck Oven
Two Pan Wide Optional Accessories	Description
BMDDDP1	Proofer for Single, Double & Triple Deck Oven
BMDDDS1	Storage Cabinet for Single, Double & Triple Deck Oven
Three Pan Wide Optional Accessories	Description
BMTDP01	Proofer for Single, Double & Triple Deck Oven
BMTDS01	Storage Cabinet for Single, Double & Triple Deck Oven

*Pan Width is based on 18" x 26" Full Size Pans

**CAUTION: STONE HEARTH MUST BE SEASONED BEFORE USE



Think Quality - Think Value - Think Service - Think BakeMax



Cooking Equipment

BakeMax America Radiant Gas Charbroiler

A Charbroiler is essential for any establishment that wants to feature smoky, char-grilled flavors on their menu. The Charbroiler design directs juices evolved during the cooking process downward onto the radiant, resulting in searing flames and enhanced smoke flavors. Perfect to cook meats, vegetables and more.



Model # BACGG24-4



Optimal Heat Distribution:

- Heavy-duty radiant system ensures even and efficient heat distribution.

Adaptable Grate Design:

- Heavy-duty reversible cast iron grates accommodate a variety of products.

Flare-Up Control:

- Angled heavy-duty cast-iron top grates effectively control flare-ups.

Ease of Cleaning:

- Individually removable radiants for effortless and convenient cleaning.

Effortless Ignition:

- Easy light pilot located conveniently at the side of each burner.

Precise Burner Control:

- Individually controlled enameled stainless-steel burners placed every 6", offering maximum output, flexibility, and low maintenance.

Selective Use Capability:

- Manual gas control valve for each burner allows the use of select burners.

Efficient Grease Management:

- Enameled grease tray with a full width catch tray funnels into a removable pan for easy cleaning.

Warranty:

- Backed by our 2-Year Limited Warranty

Technical Specifications

Model	Width	Depth	Height	Burners	BTU NG	BTU LP	Orifice #	
							NG	LP
BACGG18-2	18"	30.5"	16.2"	1	30,000	30,000	40	52
BACGG24-4	24"	30.5"	16.2"	2	60,000	60,000	40	52
BACGG36-6	36"	30.5"	16.2"	3	90,000	90,000	40	52
BACGG48-8	48"	30.5"	16.2"	4	120,000	120,000	40	52

Shipping Specifications

Model	Net Weight	Crated Weight	Crated Dimensions (W x D x H)
BACGG18-2	140lbs. / 64kg	157lbs. / 71kg	23 x 34" x 19"
BACGG24-4	182lbs. / 83kg	209lbs. / 95kg	29" x 34" x 19"
BACGG36-6	240lbs. / 109kg	284lbs. / 129kg	41" x 34" x 19"
BACGG48-8	258lbs. / 117kg	320lbs. / 145kg	52" x 34" x 19"

***Warning:** The minimum supply pressure on this appliance must be set at 4 water column inches for natural gas and 10 water column for propane gas. Each unit has a 3/4" gas connect at the rear of the appliance.

Due to continuous product improvement, specifications are subject to change without notice.

Visit www.BakeMax.com for up-to-date product information.

1-800-565-2253

OrderDesk@BakeMax.com

Cooking Equipment

BakeMax America Manual Gas Griddles

The BakeMax America BACG Series Manual Gas Griddle is designed to provide the ultimate performance and durability. As with all our heavy-duty countertop equipment, they are built to the highest commercial standards to ensure years of trouble-free service, featuring superior frame construction and stainless-steel exterior for easy maintenance. Combine all of this and our affordable prices and you have the best value for your budget.



Features:

- Available in 15", 24", 36", 48" and 60" Widths.
- Stainless-Steel Construction
- Highly Polished 3/4" Steel Griddle Plate
- Easy-to-Light Pilots through the Front Panel
- Individual Burner Control with Individually Lit Pilots
- Enameled Burners, Designed to Achieve the Best Performance
- Each burner heats 12" of the grill plate to provide an even heat distribution.
- Stainless Steel Splash Guard around the Griddle
- 4.4" Enameled Grease Tray for Easy Cleaning
- 3/4" Rear Gas Connection
- 4" Adjustable Stainless-Steel Legs
- LP Conversion Kit Included
- 2-Year Limited Warranty

Model # BACG24-2



Technical Information

Model	Width	Depth	Height	Burners	BTU NG	BTU LP	Orifice #	
							Gas	LP
BACG15-1	15"	30.5"	16.85"	1	30,000	30,000	44	54
BACG24-2	24"	30.5"	16.85"	2	60,000	60,000	44	54
BACG36-3	36"	30.5"	16.85"	3	90,000	90,000	44	54
BACG48-4	48"	30.5"	16.85"	4	120,000	120,000	44	54
BACG60-5	60"	30.5"	16.85"	5	150,000	150,000	44	54

Shipping Information

Model	Net Weight	Crated Weight	Crated Dimensions (W x D x H)
BACG15-1	140lbs. / 64kg	157lbs. / 71kg	23 x 34" x 19"
BACG24-2	182lbs. / 83kg	210lbs. / 95kg	29" x 34" x 19"
BACG36-3	240lbs. / 109kg	284lbs. / 129kg	40" x 34" x 19"
BACG48-4	258lbs. / 117kg	329lbs. / 149kg	52" x 34" x 19"
BACG60-5	315lbs. / 143kg	357lbs. / 162kg	64" x 34" x 19"

***Warning:** The minimum supply pressure on this appliance must be set at 4 water column inches for natural gas and 10 water column for propane gas. Each unit has a 3/4" gas connect at the rear of the appliance.

Think Quality - Think Value - Think Service - Think BakeMax



Cooking Equipment

BakeMax America Thermostatic Gas Griddles

The BakeMax America BATG Series Thermostatic Griddles are designed to provide the ultimate in performance and durability. As with all our heavy-duty countertop equipment, they are built to the highest commercial standards to ensure years of trouble-free service, featuring superior frame construction and stainless-steel exterior for easy maintenance. Combine all of this and our affordable prices and you have the best value for your budget.



Model # BATG24



Features

- Available in 24", 36", 48" Widths.
- Full Stainless-Steel Construction
- Highly Polished 3/4" Carbon Steel Fully Welded Griddle Plate
- Easy-To-Light Pilot at the sides of Each Burner
- Independent Heat Control for Each Burner.
- Durable Black Aluminum Knobs
- 200-575°F Energy-Saving Adjustable Thermostatic Control Valves to Achieve Precise Desired Griddle Plate Surface Temperature
- Enameled Burners Positioned every 12" Providing Heat Uniformity
- Easy-to-Light Pilots
- Stainless-Steel Splash Guards
- 4.4" Enameled Grease Tray for Easy Cleaning
- 3/4" Rear Gas Connection
- Adjustable Stainless-Steel Legs
- LP Conversion Kit Included
- 2-Year Limited Warranty

Technical Specifications

Model	Width	Depth	Height	Burners	BTU NG	BTU LP	Orifice #	
							NG	LP
BATG24	24"	30.5"	16.85"	2	70,000	70,000	43	54
BATG36	36"	30.5"	16.85"	3	105,000	105,000	43	54
BATG48	48"	30.5"	16.85"	4	140,000	140,000	43	54

Shipping Specifications

Model	Net Weight	Crated Weight	Crated Dimensions (W x D x H)
BATG24	165lbs. / 75kg	196lbs. / 89kg	28" x 34.25" x 19.3"
BATG36	234lbs. / 106kg	282lbs. / 128kg	40.25" x 34.25" x 19.3"
BATG48	258lbs. / 117kg	329lbs. / 149kg	53" x 34.25" x 19.3"

***Warning:** The minimum supply pressure on this appliance must be set at 4 water column inches for natural gas and 10 water columns for propane gas. Each unit has a 3/4" gas connect at the rear of the appliance.

Due to continuous product improvement, specifications are subject to change without notice.

Visit www.BakeMax.com for up-to-date product information.

1-800-565-2253

OrderDesk@BakeMax.com

Cooking Equipment

BakeMax America Gas Hot Plates

The BakeMax America BAFA Series Gas Hot Plates are designed to provide the ultimate in performance and durability. As with all our heavy-duty countertop equipment, they are built to the highest commercial standards to ensure years of trouble-free service, featuring superior frame construction and stainless-steel exterior for easy maintenance. Combine all of this and our affordable prices and you have the best value for your budget.



Model # BAFA4M-24



Certified to ANSI/NSF4

Features

- Available in 12", 24", and 36" Widths
- Durable Stainless-Steel Body that is very Easy to Clean
- Compact Design for Countertop Use
- 12" x 12" Heavy-duty Cast-Iron Top Grates that are designed for easy movement of pots across top sections.
- 6" Deep Front Stainless-Steel bullnose-rail is safely flush with the cook tops and functional to straddle pots, skillets and plates and serves as control protection.
- Large 7" Flame Spread offers a more efficient burn pattern for small to large pots.
- Cast Iron Double Burners for Peak Performance
- Easy-to-Light Pilot at the side of Each Burner
- Independent Controls for Each Burner
- 4" Adjustable Polished Chrome Steel Legs
- Full Width Grease Catch Tray that funnels into a removable pan for easy cleaning
- 3/4" Rear Gas Connection
- Gas Appliance Regulator Included
- LP Conversion Kit Included
- 2-Year Limited Warranty

Technical Specifications

Model	Width	Depth	Height	Burners	BTU NG	BTU LP	Orifice #	
							NG	LP
BAFA2M-12	12"	30.5"	17"	2	50,000	50,000	40	53
BAFA4M-24	24"	30.5"	17"	4	100,000	100,000	40	53
BAFA6M-36	36"	30.5"	17"	6	150,000	150,000	40	53

Shipping Specifications

Model	Net Weight	Crated Weight	Crated Dimensions (W x D x H)
BAFA2M-12	70lbs. / 32kg	93 lbs. / 42 Kg	16.25" x 34.25" x 18.5"
BAFA4M-24	121lbs. / 55kg	154 lbs. / 70 Kg	28.1" x 34.25" x 18.5"
BAFA6M-36	176lbs. / 80kg	218lbs. / 99 Kg	41" x 34.25" x 18.5"

***Warning:** The minimum supply pressure on this appliance must be set at 4 water column inches for natural gas and 10 water columns for propane gas. Each unit has a 3/4" gas connect at the rear of the appliance.

Think Quality - Think Value - Think Service - Think BakeMax



Cooking Equipment

BakeMax America Gas Stock Pots

The BakeMax America BASPS Series Gas Stock Pot is designed to provide the ultimate in performance and durability. As with all our heavy-duty countertop equipment, they are built to the highest commercial standards to ensure years of trouble-free service, featuring superior frame construction and stainless-steel exterior for easy maintenance. Combine all of this and our affordable prices and you have the best value for your budget.



Model BASPS001

- Available in (1) 3 Ring Burner and (2) 3 Ring Burners
- 90,000 BTU Output Per Burner
- Constructed of Stainless-Steel for Durability & Ease of Cleaning
- 18" x 21" Heavy-Duty Cast Iron Top Grates designed for easy movement of pots across top sections.
- Deflectors to direct waste and crumbs to drip pan
- Landing ledge, promoting safety and functionality
- Independent manual controls for each burner
- 6" highly polished chrome adjustable steel legs.
- Full width catch tray funneling into a removable pan for easy cleaning
- 3/4" Rear Gas Connect
- LP Conversion Kit Included
- Gas Appliance Regulator Included
- 2-Year Limited Warranty



3 Ring Burner



Model BASPS002

***Warning:** The minimum supply pressure on this appliance must be set at 4 water column inches for natural gas and 10 water columns for propane gas. Each unit has a 3/4" gas connect at the rear of the appliance.

Due to continuous product improvement, specifications are subject to change without notice.

Visit www.BakeMax.com for up-to-date product information.

1-800-565-2253

OrderDesk@BakeMax.com

Cooking Equipment

BakeMax America Gas Fryers

The BakeMax America BAKE Series Fryers are made of heavy-duty stainless steel with a double layer access door. Galvanized steel side panels. The drain valve is 1.5" diameter to allow for quick draining.



Features:

- Tank Capacities of 40lbs, 50lbs and 75lbs.
- 90,000, 120,000 and 150,000 BTU's/hr.
- Available in Natural Gas (NG) and Propane (LP)
- Temperature Range from 200° F to 400° F
- Stainless-Steel Long-Lasting Construction
- Double Layer Access Door
- Millivolt System (no electrical hookup required)
- Galvanized Steel Side Panels
- 1.5" Diameter opening Drain Valve for Easy Draining
- 3/4" NPT inlet in rear of unit
- Nickel Plated Rack to rest baskets
- Heat Exchange Tubes with Baffles
- 1-year Limited Warranty (2 years on fry tank)

Included Accessories:

- Drain Rod for Easy Cleaning of Drain Tube / Valve
- Twin Chrome Plated Fryer Baskets

Optional Accessories:

- Additional Baskets – Part # KE70/001
- Bracket for Joining Multiple Fryers – Part # BB2
- Left Splash Guard – Part # BB3L
- Right Splash Guard – Part # BB3R
- 4 Casters with 2 Brakes – Part#KE70/CKIT

Technical Specifications

Model	Product Dimensions (W x D x H)	Product Weight	Tank Capacity	Tank Size	Tube	Hose*	BTU NG	BTU LP
BAKEG40	16" x 33" x 48.5"	110lbs.	40lbs.	14" x 14"	3	3/4"	90,000	N/A
BAKEG50	16" x 33" x 48.5"	143lbs.	50lbs.	14" x 14"	4	3/4"	120,000	N/A
BAKEG70	20" x 34" x 48.5"	157lbs.	75lbs.	18" x 18"	5	3/4"	150,000	N/A
BAKEL40	16" x 33" x 48.5"	110lbs.	40lbs.	14" x 14"	3	3/4"	N/A	90,000
BAKEL50	16" x 33" x 48.5"	143lbs.	50lbs.	14" x 14"	4	3/4"	N/A	120,000
BAKEL70	20" x 34" x 48.5"	157lbs.	75lbs.	18" x 18"	5	3/4"	N/A	150,000

Shipping Specifications

Model	Width	Depth	Height	Weight
BAKEG40 & BAKEL40	20"	35"	51"	200lb
BAKEG50 & BAKEL50	20"	35"	51"	200lb
BAKEG70 & BAKEL70	24"	37"	51"	275lb

*Hose Not Supplied with Fryer

***Warning:** The minimum supply pressure on this appliance must be set at 4 water column inches for natural gas and 10 water columns for propane gas. Each unit has a 3/4" gas connect at the rear of the appliance.

Think Quality - Think Value - Think Service - Think BakeMax



Cooking Equipment

BakeMax America Gas Ranges

The BakeMax BAS Range Series are constructed with 430 corrosion resistant stainless steel, including interior burner box which provides extra durability and easy to clean. All supporting brackets inside burner box are made of 304 stainless steel which is resistant to oxidation and corrosion. Each top burner provides up to 25,000 BTU's. The ovens are fully enameled with porcelain interior and the oven door lifts off easily for cleaning and maintenance. Each unit is NG and is supplied with LP conversion kit.



Model# BAS360
36" 6-Burner Gas Range
and Bakery Oven



Model# BAS36-12
36" Wide 2-Burner
Gas Range with 24"
Manual Griddle and
Bakery Oven



Model# BAS36-24-2
60" Wide 6-Burner Gas Range
with 24" Manual Griddle and
Two Bakery Ovens

Technical Specifications

Model	Width	Depth	Height	Burners	BTU NG	BTU LP	Range & Griddle Orifice #		Oven Orifice #	
							NG	LP	NG	LP
BAS240	24"	35"	62.5"	4	130,000	127,000	40	53	37	52
BAS360	36"	35"	62.5"	6	185,000	183,000	40	53	33	51
BAS600	60"	35"	62.5"	10	315,000	310,000	40	53	33 & 37	51 & 52
BAS36-24-2	60"	35"	62.5"	6 with 24" Griddle	293,000	293,000	40 & 44	53 & 54	33 & 37	51 & 52
BAS36-12	36"	35"	62.5"	2 with 24" Griddle	151,000	151,000	40 & 44	53 & 54	33	51

Shipping Specifications

Model	Product Weight	Crated Weight	Crated Dimensions (W x D x H)
BAS240	276lbs. / 125kg	397lbs. / 180kg	29" x 39" x 46"
BAS360	386lbs. / 175kg	529lbs. / 240kg	47.5 x 39" x 46"
BAS600	662lbs. / 300kg	841lbs. / 382kg	65" x 39" x 46"
BAS36-24-2	708lbs. / 321kg	841lbs. / 382kg	64" x 42" x 47"
BAS36-12	418lbs. / 190kg	549lbs. / 248kg	46" x 41" x 47"

***Warning:** The minimum supply pressure on this appliance must be set at 4 water column inches for natural gas and 10 water columns for propane gas. Each unit has a 3/4" gas connect at the rear of the appliance.

Due to continuous product improvement, specifications are subject to change without notice.

Visit www.BakeMax.com for up-to-date product information.

1-800-565-2253

OrderDesk@BakeMax.com

Cooking Equipment

BakeMax America Gas & Electric Convection Oven

The BakeMax America BASCO5 Convection Ovens are built to last and can accommodate holding 9 full size pans. It can cook a variety of foods and is widely adjustable to meet the customer's needs. The electric model features a 11000W Heating Element, and the Gas Model has four burners at 45,000 BTU per burner, allowing food to be cooked quickly and efficiently. Ideal for Restaurants and Bakeries.



Models
BASCO5G
BASCO5E

Features:

- Constructed of High-Quality Stainless-Steel
- Heavy-Duty, Removeable Front Door for Ease of Cleaning
- Stainless Steel Door with Double Glass Front Window
- Porcelain-Enameled Oven Cavity with Removeable Rack Supports designed for Hassle-Free Cleaning
- Oven Cavity has Coved/Rounded Corners for Better Heat Circulation
- Interior Long-Lasting Halogen Lights
- Comes with 5 Heavy-Duty Chrome Plated Racks, with 9 Different Rack Positions at 2" Spacing
- Integrated Safety System that Shuts Off Power to the Fan when the Oven Door is Opened.
- Solid State Thermostat with a Temperature Range of 150-500°F
- Forced Air Circulation System accountable for evenly baking food and maximizing efficiency for energy savings.
- ¼ HP Blower Motor with Reversible Rotation
- Manual Heating Element Shut-Off Switch
- Two Auxiliary Cooking Features: Hold & Pulse
- Two Fan Speeds – High & Low
- 2-Year Limited Warranty



Technical Specifications

Model	Width	Depth	Height	Trays	BTU NG	BTU LP	Electrical	Oven Cavity Dims (W x D x H)
BASCO5G	38"	46.6"	61.6"	9	180,000	180,000	120V / 4.8A 720W / 1Ph	29" x 25.5" x 20"
BASCO5E	38"	46.6"	61.6"	9	240V / 51A / 11000W / 60Hz / 1Ph			29" x 25.5" x 20"
BADCO5G	38"	46.6"	71.4"	18	360,000	360,000	120V / 4.8A 720W / 1Ph	29" x 25.5" x 20"
BADCO5E	38"	46.6"	71.4"	18	240V / 102A / 22000W / 60Hz / 1Ph			29" x 25.5" x 20"

***Warning:** The minimum supply pressure on this appliance must be set at 4 water column inches for natural gas and 10 water columns for propane gas. Each unit has a ¾" gas connect at the rear of the appliance.

Think Quality - Think Value - Think Service - Think BakeMax



Cooking Equipment

BakeMax America Gas & Electric Convection Oven

The BakeMax America BADCO5 series convection oven comes with the same features of the BASCO5 Series, only with another oven stacked on top. With its space saving design, it is developed with our customers in mind and capability of holding 24 full size pans.



Models
BADCO5G
BADCO5E

Shipping Specifications

Model	Net Weight	Crated Weight	Crated Dimensions (W x D x H)
BASCO5G	492lbs.	538lbs.	43.3" x 52" x 39.4"
BASCO5E	463lbs.	509lbs.	43.3" x 55" x 39.4"
BADCO5G	913lbs.	1014lbs.	43.4" x 49.3" x 77.6"
BADCO5E	885lbs.	985lbs.	43.4" x 49.3" x 77.6"

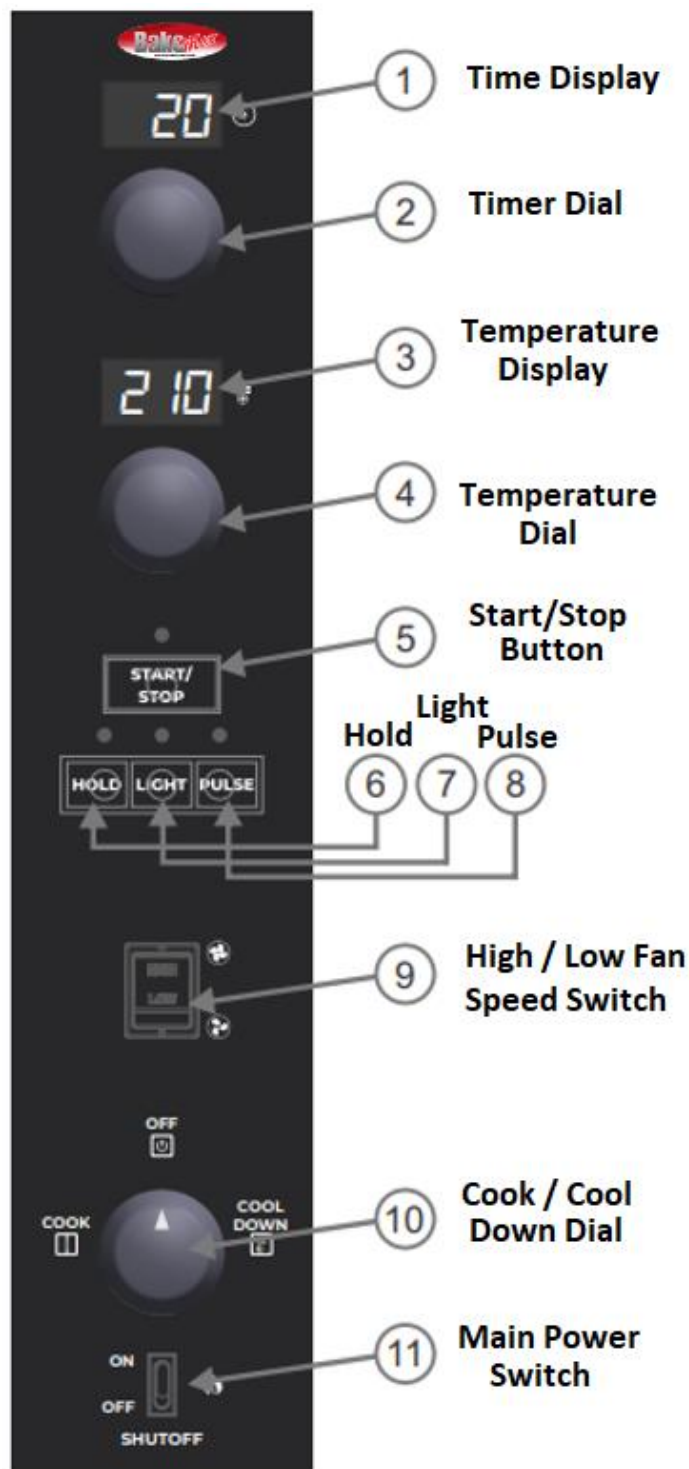

***Warning:** The minimum supply pressure on this appliance must be set at 4 water column inches for natural gas and 10 water columns for propane gas. Each unit has a 3/4" gas connect at the rear of the appliance.

Due to continuous product improvement, specifications are subject to change without notice.

Visit www.BakeMax.com for up-to-date product information.

1-800-565-2253

OrderDesk@BakeMax.com

Cooking Equipment

Greaseless Commercial Hot Air Fryer

The BakeMax BMSGF Series Air Fryer uses a combination of forced hot air, radiant heat, and an elevated perforated cooking basket to prepare frozen foods to the taste and texture as if they were deep-fat fried. Crispy on the outside and moist and tender on the inside! Ideal for start-up businesses, bars and clubs, family entertainment centers, delicatessens, snack stands, and others who wish to prepare and serve portable restaurant quality menu items at a fraction of the cost of building a commercial kitchen.



Features:

- Capacity: 2lbs. per batch
- LCD Color Touch Screen Display – Create and Edit up to 15 different recipes with names, times, and temperatures.
- Simple and easy to operate you don't need a culinary trained chef or cook to produce crispy and delicious menu items!
- Greaseless Fryers are healthier with 20% to 40% less fat compared to deep-fat frying and without the mess and hazards of using hot grease. Also faster, 30-40% faster (on average) than a convection oven!
- No Vented Hood System Needed
- 1-Year Limited Warranty

Electrical Options

- The **120V 1740W Model# BMSGF201** utilizes a standard 120V plug, NEMA 5-15P and can be plugged into any standard outlet. It takes approximately 9 minutes to warm up from room temperature to 420°F.
- The **120V 2200W Model# BMSGF202** requires a dedicated 20A circuit and utilizes a 20A plug, NEMA 5-20P. It takes approximately 6 1/2 minutes to warm up from room temperature to 420°F.
- The **208V 4326W Model# BMSGF203** utilizes a single phase, 4-wire, 30A plug, NEMA #14-30P. It takes approximately 1.5 to 2.5 minutes to warm up from room temperature to 420°F, depending on the input voltage. Since the pre-warm is so quick with this model, it provides the operator with “Cook to Order” capabilities.

Technical Specifications (W x D x H):

- External Dimensions: 21” x 20” x 13.5”
- Cooking Basket: 12” x 12” x 2”

Shipping Specifications (W x D x H):

- Crated Dimensions: 23.5” x 23.5” x 18”
- Crated Weight: 70lbs.



Think Quality - Think Value - Think Service - Think BakeMax



Cooking Equipment

Greaseless Commercial Hot Air Fryers

The BakeMax BMSGF5 and BMDGF5 (Double Stacked) uses a combination of forced hot air, radiant heat, and an elevated perforated cooking basket to prepare frozen foods to the taste and texture as if they were deep-fat fried. Crispy on the outside and moist and tender on the inside!



**Model BMDGF5
Double Stacked**

Features:

- Capacity: 5lbs. per batch
- LCD Color Touch Screen Display – Create and Edit up to 15 different recipes with menu names, times, and temperatures.
- Simple and easy to operate you don't need a culinary trained chef or cook to produce crispy and delicious menu items!
- Greaseless Fryers are healthier with 20% to 40% less fat compared to deep-fat frying and without the mess and hazards of using hot grease.
- Cooks 30% to 40% faster than convection ovens without the mess and hazards of using hot grease!
- No Vented Hood System Needed
- Prepares French fries, egg rolls, corn dogs, chicken tenders, tacos and other "fried foods;" Grills up to 50 hot dogs in 5 minutes; Bakes pizzas, pretzels, and hot sandwiches!
- 1-Year Limited Warranty



Model BMSGF5

Electrical Options (Single Phase, 50/60Hz)

- 208V / 29A / 5760W / Nema 6-30R Plug
- 240V / 24A / 5750W / Nema 6-30R Plug

Technical Specifications (W x D x H):

- External Dimensions: 29" x 21" x 25"
- Cooking Basket Dimensions: 16.5" x 16.5" x 3"

Shipping Specifications (W x D x H):

- Crated Dimensions: 37" x 30" x 29"
- Crated Weight: 175lb.

Due to continuous product improvement, specifications are subject to change without notice.

Visit www.BakeMax.com for up-to-date product information.

1-800-565-2253

OrderDesk@BakeMax.com

Cooking Equipment

Greaseless Commercial Hot Air Fryers

The BakeMax BMSRAF and BMDRAF (Double Stacked) uses dual heating elements to produce a combination of forced hot air and radiant heat. With elevated perforated cooking basket, prepares frozen foods to the taste and texture as if they were deep-fat fried. The BMSRAF can now cook at temperatures up to 525° F, which results in cooking times that are comparable to deep-fat fryers for french fries and other delicious menu items. Prepare and serve menu items that are crispy on the outside and moist and juicy on the inside, without the mess and hazards of hot grease!



Model BMDRAF



- **Unsurpassed Versatility** – Prepares french fries, chicken tenders, tacos and more; Grills up to 50 hot dogs in just 4 minutes; Bakes Pizzas, Flatbreads, Pretzels, and hot sandwiches in just 2 to 4 minutes!
- **Increased Speed of Service** – Prepares frozen french fries in less than 3 ½ minutes!
- **No Exhaust Vents Required** – Uses both a heated catalytic converter, and a two-stage air filtration system!
- **Offer Healthier Foods** – Greaseless Fryers are healthier with 20% to 40% less fat compared to deep-fat frying and without the mess and hazards of using hot grease.
- **Easy to Program** – Smart Phone Style Touch Screen allows you to create and edit up to 108 recipes with menu names, times, and temperatures.
- **Hold & Reheat** – Twice the holding times compared to deep fat fried menu items – (important for takeout orders). Reheat menu items in 90 seconds or less during rush periods!
- 1-Year Limited Warranty

Electrical Options (Single Phase, 50/60Hz)

- 208V / 29A / 5760W / Nema 6-30R
- 240V / 24A / 5750W / Nema 6-30R

Technical Specifications (W x D x H):

- External Dimensions: 29" x 21" x 23.4"
- Cooking Basket: 16.5" x 16.5" x 3"

Shipping Specifications (W x D x H):

- Crated Dimensions: 37" x 30" x 29"
- Crated Weight: 175lb.



Think Quality - Think Value - Think Service - Think BakeMax



Cooking Equipment

Conveyor Toasters

The BakeMax BMCT Series Conveyor Toaster are perfect for toast, bagels and more. With its attractive design and easy to use functions this toaster is ideal for Restaurants, Hotels, Cafes, Delis and more.

Features:

- Attractive and easy to clean Stainless-Steel Design
- Available in 1, 2 and 3 slice feeds
- 1.5" clearance
- Faster and consistent heat with quartz-infrared heaters
- Easy to use control takes the guesswork out of temperature and speed control settings
- Variable speed and top / bottom heat control for the perfect toast each time
- Energy efficient operation with power saver switch that reduces electricity consumption up to 75% and quick recovery with quartz heaters
- Extendable stainless-steel conveyor belt for easy loading
- Safe load up area with full width coated front burner guard and cool to the touch exterior
- Smart crumb tray keeps the breadcrumbs from falling under the toaster and easily removable to clean
- Heated holding area to keep toast at the perfect temperature
- High-limit switch prevents toaster from overheating, protecting critical component parts
- 1-Year Limited Warranty



BMCT300 / BMCT305



Technical Specifications

Model	Slice Feed	Slices / Hour	Belt Width	Dimensions (WDH)	Electrical	Net Weight
BMCT150	1	180	5.9"	13.4" x 25.2" x 15.8"	120V / 15A / 1800W / 60hz / Nema 5-20P	40lbs.
BMCT300	2	360	9.8"	14.6" x 25.2" x 15.8"	220V / 12.2A / 2800W / 60hz / Nema 6-20P	44lbs.
BMCT305	2	360	9.8"	14.6" x 25.2" x 15.8"	120V / 15A / 1800W / 60Hz / Nema 5-20P	44lbs.
BMCT450	2	500	11.8"	17.7" x 25.2" x 15.8"	220V / 16A / 3600W 60Hz / Nema 6-20P	55lbs.

Shipping Specifications

Model	Packaging Dimensions (WDH)	Packaging Weight
BMCT150	17" x 26" x 20"	44lbs.
BMCT300	22" x 26" x 20"	55lbs.
BMCT305	22" x 26" x 20"	55lbs.
BMCT450	27" x 26" x 20"	66lbs.



BMCT150



BMCT450

Due to continuous product improvement, specifications are subject to change without notice.

Visit www.BakeMax.com for up-to-date product information.

1-800-565-2253

OrderDesk@BakeMax.com

Cooking Equipment

Conveyor Baker

The BakeMax BMCB001 Conveyor Baker with 14" Wide Conveyor Belt is great for baking all types of bread, pizza, bagels, cookies and more. Designed to provide consistent heat with top and bottom infrared heaters and variable speed controls. Great for restaurants, convenience stores, cafes, and grocery stores.

Features:

- Body Constructed Completely of Stainless Steel
- Fast Start-Up due to the powerful 3,600-watt heating source
- Quartz sheathed heaters (2 above, 2 below conveyor) regulated by separate controls.
- Adjustable heat 158°F – 500°F (70°C – 260°C)
- Touch Safe™: with its burn proof design prevents accidental burns during operation
- Variable Speed Control
- Stainless Steel Conveyor Belt
- Bakes up to sixteen 12" or twelve 14" parbaked pizzas per hour
- Menu items can be cooked in the same oven to offer superior flexibility
- Opening Dimensions: 3.25" x 14"
- 1-Year Limited Warranty



Intertek

Shipping Specifications:

- Packaged Dimensions (WDH): 37" x 26" x 19"
- Packaged Weight: 66lbs.

Technical Specifications:

- Electrical: 220V / 15A / 3.6kW / 60Hz / Nema 6-20P
- Dimensions (No Trays: WDH): 18.75" x 30" x 15.5"
- Dimensions (One Tray: WDH): 18.75" x 40.5" x 15.5"
- Dimensions (Both Trays: WDH): 18.75" x 47" x 15.5"
- Net weight: 60lbs.

Temperature & Time Settings

Dial Setting	Temperature	Time (Minutes' Seconds")
1	158-194°F (70-90°C)	10' 5"
2	194-230°F (90-110°C)	8' 50"
3	266-284°F (130-140°C)	7' 45"
4	284-311°F (140-155°C)	6' 35"
5	311-356°F (155-180°C)	5' 45"
6	365-401°F (185-205°C)	5' 05"
7	401-428°F (205-220°C)	4' 20"
8	464-500°F (240-260°C)	3' 30"
9	482-500°F (250-260°C)	1' 45"
10	482-500°F (250-260°C)	1' 20"

Baking Settings

Product	Top Heat	Bottom Heat	Belt Speed
Pizza 12" Parbaked	300F	400F	6 Minutes
Meat & Cheese Sandwich	450F	300F	4 minutes
Meatball	500F	350F	2 Minutes
Bagel (open)	500F	400F	2 Minutes
1 oz Cookies	200F	250F	10 Minutes
Garlic Bread (Lightly Seasoned)	500F	500F	2 Minutes
Fish Sizzle Platter	400F	500F	6 Minutes

**Above settings are guidelines only; product portions and temperatures can cause variations in product results.

Think Quality - Think Value - Think Service - Think BakeMax



Food Preparation Equipment

Titan Series Countertop Bone Saw

The BMCBS01 is made of stainless steel for durability and longevity, as well as being easy to clean. This unit is great for delis, meat shops, grocery stores, and restaurants. This unit comes with 3 different style blades, providing you flexibility in your cutting needs. Blades included are for Frozen Fish, Frozen Meat and Bone.



Intertek



Features:

- Includes Three 65" Blades (Frozen Fish, Frozen Meat, Frozen Bone)
- 8.25" Max Cutting Height
- 17.2" x 18.3" Feeding Table
- Adjustable Thickness Gauge to Provide Consistent Product Cuts
- Safety Switch to Automatically Cut-Off Power to the unit when the Door is Opened
- Hand Guard provides a Safe and Sanitary Operation

Technical Specifications:

- Product Dims (WDH): 18.9" x 18.1" x 34.3"
- 120v / 6.82A / 750W / 1PH / 60HZ
- Product Weight 82lbs.

Shipping Specifications:

- Packaged Dims (WDH): 24" x 24" x 40"
- Shipping Weight: 122lbs.

Bread Crumb Machine (Bread Mill)

The BakeMax BMBM001 Bread Crumb Machine makes use of stale bread. It produces breadcrumbs easily with its powerful 1HP motor producing up to 220 lbs. of crumbs an hour. Provides high performance and easy maintenance.



Features:

- Constructed Completely of Stainless-Steel
- Powerful 1 HP Motor can produce up to 220 lb. of crumbs an hour and offers 3450 RPM
- Suitable for dried up bread or rolls and crackers. (Bread & rolls should be cut up into small pieces before being placed in the hopper.)
- Comes with 0.9mm & 1.5mm Screens
- Blade made of SAE 1020 steel
- Exterior Dimensions (WDH): 10.75" x 14" x 28"
- Hopper Opening: 4.75"
- Hopper Depth: 11.5"
- 110V / 13.8A / 60Hz / 5-20P Plug
- Weight 49lbs.
- Packaged Dimensions (WDH): 15" x 13" x 28"
- Packaged Weight: 60lbs.
- 1-Year Limited Warranty

Due to continuous product improvement, specifications are subject to change without notice.

Visit www.BakeMax.com for up-to-date product information.

1-800-565-2253

OrderDesk@BakeMax.com

Food Preparation Equipment

Heavy Duty Meat Grinders

The BakeMax BMMG001 & BMMG002 Meat Grinders are intended for heavy duty work in commercial food processing applications. They are reliable under the most demanding conditions. These units are great for Restaurants, Delis, and Meat Shops.



BMMG001 / BMMG002

BMMG001 Features:

- 1HP Motor Capable of up to 485 lbs./hr.
- #12 Hub
- 2 Plates included (6mm & 8mm)
- Constructed Completely in Stainless-Steel
- Designed for Easy Maintenance & Conforms to all Safety Standards
- Energy-Efficient Motor and Precision Gear Drive
- Forward & Reverse Switch
- 120V / 8A / 850W / 60Hz / 1Ph
- Product Dimensions (WDH): 8" x 18" x 16"
- Product Weight: 55 lbs.
- Packaged Dimensions (WDH): 13" x 18" x 16"
- Packaged Weight: 62 lbs.
- Plug & Go Nema 5-15P Plug
- 1-Year Limited Warranty

BMMG002 Features:

- Powerful 1.5HP Motor capable of grinding up to 880lbs. of Meat per Hour
- #22 Hub
- 2 Plates Included (6mm & 8mm)
- Constructed completely in Stainless-Steel for Durability and Ease of Cleaning
- Designed for Easy Maintenance & Conforms to all Safety Standards
- Energy-Efficient Motor and Precision Gear Drive
- 120V / 10A / 1120W / 60Hz / 1Ph / Plug & Go Nema 5-15P Plug
- Product Dimensions (WDH): 10" x 20" x 20"
- Net Weight: 88 lbs.
- Packaged Dimensions (WDH): 14" x 24" x 23"
- Packaged Weight: 95 lbs.
- Plug & Go 5-15P Plug
- 1-Year Limited Warranty



BMMGA01 Meat Grinder
Mixer Attachment

Features:

- Easy to use
- Sausage Stuffer Spout
- Fits Standard Drive Unit

Think Quality - Think Value - Think Service - Think BakeMax



Food Preparation Equipment

Titan Series Meat Grinders

Prepare freshly ground meat with ease using the BakeMax Titan Series BMMG003 & BMMG04 Meat Grinders. Constructed of anodized aluminum alloy and stainless steel for durability and ease of cleaning. Forward and reverse switch for ease of use. These also include emergency shut off switch for added safety. These units are great for Restaurants, Delis, and Meat Shops.



Model BMMG003 & BMMG004



BMMG003 Features:

- 1HP Motor capable of up to 350lbs/hr.
- #12 Hub
- 2 Meat Plates Included (4.5mm & 8mm)
- Forward & Reverse Switch
- 120V / 7A / 850W / 60HZ / 1 Phase
- Product Dimensions (WDH): 9" x 20" x 20"
- Product Weight: 32 lbs.
- Package Dimensions (WDH): 11" x 22" x 24"
- Package Weight: 34 lbs.
- Plug & Go Nema 5-15P Plug
- 1-Year Limited Warranty

BMMG004 Features:

- 1.5HP Motor capable of grinding up to 660 lbs. of Meat per Hour
- #22 Hub
- 2 Meat Plates Included (4.5mm & 8mm)
- Forward & Reverse Switch
- 120V / 9A / 1100W / 60HZ / 1Ph
- Product Dimensions(WDH): 9.7" x 20.9" x 20.4"
- Product Weight: 41lbs.
- Packaged Dimensions (WDH): 11" x 24" x 24"
- Packaged Weight: 44lbs.
- Plug & Go Nema 5-15P Plug
- Meat Pusher Included
- 1-Year Limited Warranty



Model BMMG005

BMMG005 Features:

- Powerful 2HP Motor capable of grinding up to 1100lbs. of Meat per Hour
- #32 Hub
- 2 Meat Plates included (4.5mm, 8mm)
- 120V / 1500W / 60HZ / 1Ph
- Product Dimensions (WDH): 10.7" x 23" x 20.8"
- Net Weight: 61lbs.
- Packaged Dimensions (WDH): 12" x 26 x 24"
- Packaged Weight: 66lbs.
- Plug & Go Nema 5-15P Plug
- Meat Pusher Included
- 1-Year Limited Warranty

Due to continuous product improvement, specifications are subject to change without notice.

Visit www.BakeMax.com for up-to-date product information.

1-800-565-2253

OrderDesk@BakeMax.com

Food Preparation Equipment

Manual Meat Slicers

The BakeMax BMMSM Series Manual Meat Slicer is constructed from polished anodized aluminum for durability and ease of cleaning. Their belt driven motor makes them great for cutting deli meats and firm vegetables. Perfect for Restaurants, Sub Shops, Cafés, Delis and more.



Features:

- Available in 8", 10" and 12" Blade
- Polished Anodized Aluminum Body
- Built in Blade Sharpener
- Belt Driven
- 350 RPM
- Food Guard
- Adjustable Slicing Thickness
- Emergency Shut-Off Switch
- 120V / 50/60Hz / 1 Ph
- Plug & Go Nema 5-15P Plug
- 1-Year Limited Warranty



BMMSM08 Technical Specification:

- 8" Blade and 0.2-12mm cutting thickness
- Exterior Dimensions (WDH): 15.7" x 14.7" x 12"
- Net Weight: 27lbs.
- Packaged Dimensions (WDH): 21" x 17" x 15"
- Packaged Weight: 32lbs.

BMMSM10 Technical Specification:

- 10" Blade and 0.2-15mm cutting thickness
- Exterior Dimensions (WDH): 20" x 16.5" x 14"
- Net Weight: 34lbs.
- Packaged Dimensions (WDH): 23" x 19" x 17"
- Packaged Weight: 44lbs.

BMMSM12 Technical Specification:

- 12" Blade and 0.2-16mm cutting thickness
- Exterior Dimensions (WDH): 23.5" x 20" x 16.5"
- Net Weight: 52lbs.
- Packaged Dimensions (WDH): 25" x 21" x 19.5"
- Packaged Weight: 58lbs.



Think Quality - Think Value - Think Service - Think BakeMax



Food Preparation Equipment

Vegetable Cutters & Slicers

The BakeMax® BMVC001 Vegetable Cutter is a countertop machine for slicing, grating and shredding fruits & vegetables. With its robust design and stainless-steel construction, makes it a great choice for Restaurants, Delis, Cafes and more. This food processor comes with 2 knives: 2.5mm and 4.5mm and 3 shredding discs: 3mm, 4mm and 7mm.



Features:

- 3/4 HP Motor
- Long Lasting and Easy to Clean Stainless-Steel Construction
- 2 Slicing Knives Included: 2.5mm and 4.5mm
- 3 Shredding Discs Included: 3mm, 4mm, and 7mm
- Automatic Shut-Off when top Lid is Opened for Safety
- 110V / 5A / 550W / 60Hz
- Plug & Go 5-15P Plug
- Dimensions (WDH): 20" x 9" x 22.44"
- Net Weight: 51lbs.

BMVC001 Shipping Specification:

- Packaged Dimensions (WDH): 23" x 12" x 23"
- Packaged Weight: 60lb

BMVC001 Additional Blades:

- Shredding Discs (1.5mm, 3mm, 4mm, and 7mm)
- Slicing / Knife Discs (1mm, 2mm, 3mm, 4.5mm, 8mm, and 10mm)
- Dicing Discs (5mm, 8mm, 10mm, and 12mm)



BMVS001 Vegetable Slicer Mixer Attachment

The BakeMax® Vegetable Slicer Mixer Attachment utilizes the Front Attachment Hub on your BakeMax Mixer. The BMVS001 makes easy work of shredding cabbage, slicing potatoes into chips, grating/shredding cheese, slicing nuts, slicing hard and soft fruit, and vegetables. The vegetable slicer attachment is compliance for hygiene standard and interchangeable with #12 Hub.



Features:

- Durable Construction & Easy to Clean
- Uses Common #12 Hub
- Includes One Slicing or Shredding Disc
- Packaged Dimensions(W x D x H): 14" x 19" x 13"
- Packaged Weight: 20lbs.

Optional Accessories:

- Shredding Discs (1.5mm, 2mm, 3mm, 5mm, 6.5mm, 8mm, and 9mm.)
- Slicing / Knife Discs 3mm

Due to continuous product improvement, specifications are subject to change without notice.

Visit www.BakeMax.com for up-to-date product information.

1-800-565-2253

OrderDesk@BakeMax.com

Heated Display Cases

Titan Series Self-Service Heated Display Cases

Increase impulse sales by displaying your sandwiches, burgers, wraps, pizzas and more with the 31.5" wide BakeMax BMHGG01 Titan Series Self-Serve Heated Display Case. With its slanted shelf design for better product visibility and 1160W of heating power to maintain food safe temperatures. The BakeMax BMHGG01 is the ultimate grab and go display warmer for any convenience store, cafeteria, concession stand or other self-serve counter.

Features:

- Constructed with stainless steel, tempered glass sides and fixed rubber feet for extra durability.
- Adjustable thermostatic controls and temperature range of 30-90°C (86-194°F) to maintain food safe temperatures.
- Independent heat & light controls for each shelf to allow flexibility when merchandising a variety of foods.
- Two slanted shelves with adjustable divider rods allowing you to display a wide variety of foods. 8 rods included
- Merchandising / Price Tag Strip
- 1-Year Limited Warranty

Replacement Accessories:

- Merchandising / Price Tag Strip - Part # HGG01/018
- Adjustable Divider Bar – Part # HGG01/018

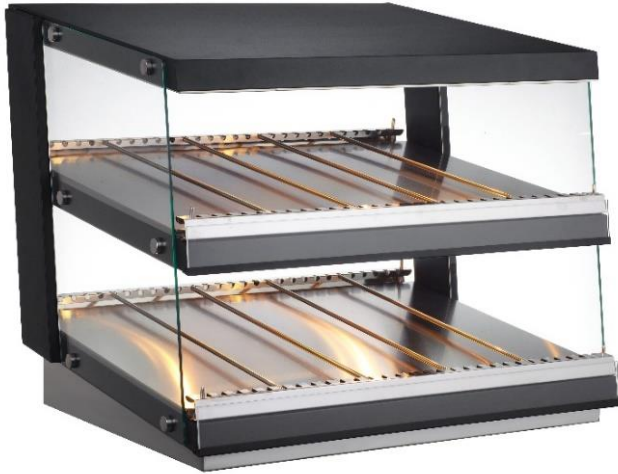

Model BMHGG01



Technical Specifications:

- Product Dimensions (WDH): 31.5" x 27.6" x 27.2"
- Product Weight 90.5lbs.
- 120V / 10A / 1160 W / 60Hz / 1Ph
- Plug & Go 5-15P Nema Plug

Shipping Specifications:

- Packaged Dimensions (WDH) 34" x 30.2" x 29"
- Packaged Weight 97lbs.



Tempered Glass

Adjustable
Divider Bars

Merchandising /
Price Tag Strip

Think Quality - Think Value - Think Service - Think BakeMax



Heated Display Cases

Titan Series Full-Service Heated Display Cases

Increase impulse sales with a BakeMax BMCBF Titan Series Heated Display Case. Ideal for convenience stores, concession stands, kiosks, and snack stations, display your food while keeping them at food safe temperatures.



Model BMCBF18

Features:

- Stainless Steel Construction
- 3 Adjustable Chrome Plate Shelves
- Removable Water Tray to Add Humidity
- Manual Temperature Control from 85-190°F
- External Temperature Display
- Internal Top Light
- Front Top Light Box with Customizable Decal
- Available in 18" Wide (BMCBF18) & 25" Wide (BMCBF25)
- Plug & Go Nema 5-15P Plug
- 1-Year Limited Warranty

Model BMCBF18:

- Product Dimensions (WDH) 18" x 17.8" x 30.9"
- Shelf Size: 15.4" W x 13.3" D
- Product Weight: 48.5lbs / 22 kg
- 120V / 7.2A / 786W / 60Hz / 1Ph /

Model BMCBF25:

- Product Dimensions (WDH) 25.5" x 19" x 30.9"
- Shelf Size: 22.6" W x 13.3" D
- Product Weight: 59.5lbs / 27 kg
- 120V / 9.5A / 1050 W / 60Hz / 1Ph



Shipping Specifications:

Model BMCBF18

- Packaged Dimensions (WDH): 21" x 21.1" x 32.8"
- Packaged Weight: 50.5lbs / 22.9 kg

Model BMCBF25

- Packaged Dimensions (WDH): 28.3" x 21.1" x 32.8"
- Packaged Weight: 61.5lbs / 27.9 kg



Model BMCBF25

Due to continuous product improvement, specifications are subject to change without notice.

Visit www.BakeMax.com for up-to-date product information.

1-800-565-2253

OrderDesk@BakeMax.com

Heated Display Cases

Titan Series Heated Display Cases

Display your food while keeping them at food safe temperatures with a BakeMax BMTSC Titan Series Heated Display Case. With sliding doors on both sides of the unit, they are perfect for increasing impulse sales in convenience stores, concession stands, kiosks, and snack stations.



Model BMTSC27



Features:

- Brilliant LED Lighting
- Removable Water Tray to Add Humidity
- Adjustable Temperature Controls 85-190°F
- Exterior Temperature Display
- Three Adjustable Chrome Plated Shelves
- Tempered Glass
- Shelf Load Capacity of 22lbs.
- Self-serve front sliding doors and easy filling rear sliding doors. (Model BMTSC14 has hinged front and back doors.)
- Product Color: Dark Gray
- Available in the following widths:
 - 14" (Model BMTSC14)
 - 27" (Model BMTSC27)
 - 36" (Model BMTSC36)
 - 48" (Model BMTSC48)



Water Pan located in front of BMTCS14 and in back for the BMTCS27 / 36 / 48



Temperature Display

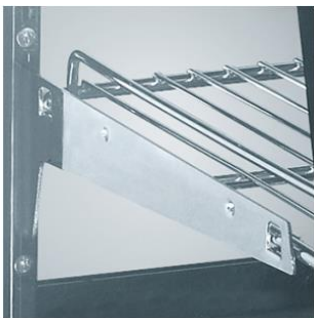

Chrome Plated Shelves



LED Lighting



Temperature Control

Indicator Light

Heat and LED Switches

Think Quality - Think Value - Think Service - Think BakeMax



Heated Display Cases

Titan Series Heated Display Cases



Model BMTSC14



Model BMTSC36



Model BMTSC27



Model BMTSC48

Model	External Dimensions (WDH)	Packaged Dimensions (WDH)	Net Weight	Packaged Weight	Bottom Shelf	Middle Shelf	Top Shelf
BMTSC14	14" x 19.1" x 26.1"	17" x 23" x 28"	45 lbs.	60 lbs.	11.4" x 13.7"	11.4" x 12.4"	11.4" x 11.3"
BMTSC27	27" x 19.1" x 26.1"	30" x 23" x 28"	74 lbs.	90 lbs.	13.6" x 24.4"	12" x 24.4"	11" x 24.4"
BMTSC36	36" x 19.1" x 26.1"	39" x 23" x 28"	92 lbs.	120 lbs.	33.7" x 13.6"	33.7" x 12.4"	33.7" x 11.3"
BMTSC48	48" x 19.1" x 26.1"	51" x 23" x 28"	118 lbs.	150 lbs.	45.7" x 13.6"	45.7" x 12.4"	45.7" x 11.3"

Model	Voltage	Phase	Amps	Watts	Hertz	NEMA
BMTSC14	120	1	7.1	800	60	5-15P
BMTSC27	120	1	9	1000	60	5-15P
BMTSC36	120	1	9.4	1100	60	5-15P
BMTSC48	120	1	12.5	1500	60	5-15P



Due to continuous product improvement, specifications are subject to change without notice.

Visit www.BakeMax.com for up-to-date product information.

1-800-565-2253

OrderDesk@BakeMax.com

Refrigerated Display Cases

Grab & Go Refrigerated Floor Display Cases

BakeMax open-air coolers are perfect for merchandising items in gas stations, grocery stores, and other places where chilled snacks and beverages are sold. Products stored in an open fridge remain easily within reach of shoppers, boosting impulse sales at your establishment.



Model BMGG019



Model BMGG024



Model BMGG036



Model BMGGS36



Specifications

Model	External Dimensions (WDH)	Packaged Dimensions (WDH)	Net Weight	Packaged Weight	Capacity
BMGG019	19" x 26.5" x 69"	22" x 29" x 72"	212lbs.	240lbs.	220L
BMGG024	24" x 30" x 67"	27" x 33" x 70"	200lbs.	230lbs.	250L
BMGG036	36" x 33.3" x 60"	39" x 36" x 63"	302lbs.	335lbs.	390L
BMGGS36	36" x 31" x 57"	39" x 34" x 60"	300lbs.	330lbs.	390L

Electrical Information

Model	Voltage	Phase	Amps	Watts	Hertz	Plug
BMGG019	120	1	8.1	970	60	5-15P
BMGG024	120	1	9	1000	60	5-15P
BMGG036	120	1	9.4	1100	60	5-15P
BMGGS36	120	1	11.6	1260	60	5-15P



Think Quality - Think Value - Think Service - Think BakeMax



Refrigerated Display Cases

Titan Series Refrigerated Display Cases

The BakeMax BMRCD Titan Series Countertop Refrigerated Display Case will help you increase impulse sales with its brilliant space saving design and 360° product view. These display cases feature 4 glass sides, lit with internal LED lighting, 3 adjustable chrome plated shelves and a digital control panel.



Model BMRCD01



Features:

- Available with a single door (BMRCD01) or pass-through double doors (BMRCD02)
- Temperature range: 0-12°C / 32 - 54°F
- Forced Air Circulation, providing air flow around your products
- 4 Sides of Double Glass Panels
- 360° Product View
- Internal LED top lighting for enhanced product display
- Digital Temperature Control
- Three Adjustable Chrome Plated Shelves
- Shelf Load Capacity of 32lbs. each
- Ventilated Cooling System
- Automatic Defrost
- 1-Year Limited Warranty
- **BMRCD01** Product Dimensions (WDH): 16" x 16.75" x 38.5"
- Shelf Size: 15" x 13.5"
- **BMRCD02** Product Dimensions (WDH): 16.75" x 16.75" x 38.5"
- Shelf Size: 14.1" x 12.4"
- 110V / 180W / 60Hz / 1Ph
- Plug & Go 5-15P Plug
- Refrigerant: R290
- Net Weight 80lbs. / 36kg

Shipping Specifications:

- Packaged Dimensions (WDH): 19" x 19" x 41"
- Packaged Weight 86lbs.



Model BMRCD02



Due to continuous product improvement, specifications are subject to change without notice.

Visit www.BakeMax.com for up-to-date product information.

1-800-565-2253

OrderDesk@BakeMax.com

Refrigerated Display Cases

Titan Series Full-Service Refrigerated Display Cases

The BakeMax BMREF Titan Series Countertop Refrigerated Display Case is great for Restaurants, Cafes, Cafeterias, Hotels and more. This unit will help you increase your impulse sales with its beautiful, curved glass design and LED lights.



Model BMREF28



Features:

- Available in 28" Wide (BMREF28) or 35" Wide (BMREF35)
- Temperature range: 0-12°C / 32 - 54°F
- Forced Air Circulation
- 4 Sides of Double Glass Panels giving 360° Product View
- Curved Front Glass provides an elegant look
- Internal LED Top Lighting for enhanced product display
- Sliding Back Doors for easy access to your products
- Digital temperature display & controls
- Adjustable Chrome Plated Shelves with a Capacity of 32lbs
- Ventilated Cooling System
- Environment Friendly R290 Refrigerant
- Air Duct in Front Panel Removes Condensation Water from Curved Front Glass
- Automatic Defrost
- 1-Year Limited Warranty

BMREF28 Technical Specifications:

- Product Dimensions (WDH): 27.6" x 22.5" x 27"
- Shelf Sizes (W x D): Top Shelf: 25" x 13.25"
Bottom Shelf: 25" x 14.5"
- Shelf Max Load Capacity: 32lb
- Electrical: 120V / 160W / 60Hz / 1Ph
- Plug & Go 5-15P Plug
- R290 Refrigerant
- Net Weight: 141lbs. / 64kg

BMREF35 Technical Specifications:

- Product Dimensions (WDH): 35.4" x 22.5" x 27"
- Shelf Sizes (WD): Top 32" x 13.25"
Bottom 32" x 14.5"
- Shelf Max Load Capacity: 32lb
- Electrical: 120V / 160W / 60Hz / 1Ph
- Plug & Go 5-15P Plug
- R290 Refrigerant
- Net Weight: 156lbs. / 71kg

BMREF28 Shipping Specifications:

- Packaged Dimensions (WDH): 31" x 25" x 30"
- Packaged Weight: 146lbs. / 66kg

BMREF35 Shipping Specifications:

- Packaged Dimensions (WDH): 38" x 25" x 30"
- Packaged Weight: 162lbs. / 73kg

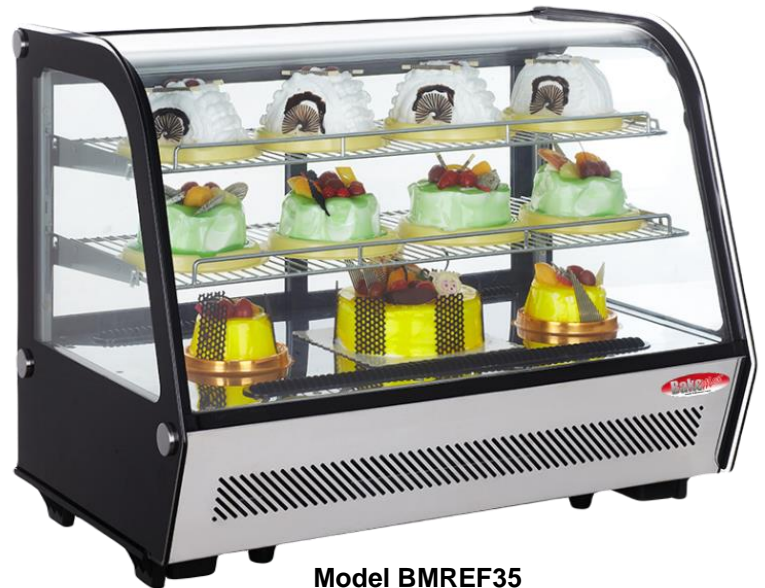

Model BMREF35



Think Quality - Think Value - Think Service - Think BakeMax



Warranty & Service

BakeMax provides a 1-Year Limited Parts and Labor Warranty on most items, there are select items which carry a Limited 2-Year Warranty. Extended Warranty is available on some products. Please contact us for details. The Warranty is not transferable and is limited to original installation of equipment sold by BakeMax for the original user.

For all Warranty Claims, Proof of Purchase and/or Serial Number is required. Once the machine is approved, BakeMax will provide our customers with on-site Warranty Coverage on all equipment more than 100lbs. BakeMax assumes no responsibility for down time or loss of product. Repairs must be Pre-Authorized by BakeMax and have a Service Authorization Number issued prior to commencing Warranty Service.

Warranty begins 10-Days after shipping from warehouse; delays in installation which would extend the Warranty must be Approved. All equipment must be installed and connected by Qualified Professionals in accordance with the Manual Specification. Products shipped are to be inspected at time of delivery, the receiver is responsible for inspection.

Any abuse or improper use of the equipment will void the warranty. This includes failure to follow all cleaning instructions, improper installation, improper maintenance, failure to follow capacity charts, improperly wired electrical connections. The Warranty does not apply to abuse, willful or accidental damage, or to products used for other than their intended purpose. Normal wear parts such as Accessories, Attachments, or Electrical Components such as Fuses, Bulbs, Elements, and Switches carry a 90-Day Warranty only.

Bench Warranty (Machines Weighing 100 lb. or less)

Once the machine is Approved for Warranty Service, if the machine requires Warranty work in less than 30 days of purchase date, BakeMax will pay all shipping charges. Once the machine is received and repaired it will be returned to the user at BakeMax expense. Freight Damages during return shipping is the responsibility of the owner of the machine.

The following is **not** covered under the BakeMax Warranty:

1. Overtime Labor Rates are not covered by BakeMax.
2. All parts will be shipped via Ground Courier only; If Express Shipping is required, it will be the responsibility of the Customer or Dealer.
3. Travel for Warranty Service is covered up to 100 Miles / 160 Km Roundtrip, any further mileage will be the responsibility of the Customer or Dealer.
4. There is no on-site Warranty Service for Residential Addresses or addresses outside of the contiguous United States (*Lower 48*) or *Canadian Provinces*

***Machines sold outside of the contiguous United States(Lower 48), or Canadian Provinces will carry 1-Year Parts Warranty only.*

Terms & Conditions

Terms

Net 15 days subject to Credit Approval. All past due Accounts are subject to 2% per month Service Charge as per Credit Application. We accept Visa, MasterCard, and Discover Credit Cards. We also accept E-Transfer & Wire Transfer, additional fees may apply.

Pricing

All prices are subject to change without notice. All prices are Sales Tax Extra, should you be claiming Tax Exemption, Tax Exempt Forms must accompany your Purchase Order. BakeMax products are sold in Canadian and US Dollars. BakeMax is not responsible for specifications errors or printing errors.

Shipping

Free shipping to Canada (Excluding Yukon, Northwest Territories & Nunavut) and the U.S. (Lower 48) Minimum order \$6,000 for BakeMax and \$10,000 for BakeMax America Cooking Line. Tailgate Delivery is \$90.00 minimum. All checks made Payable to Titan Ventures International Inc. BakeMax is not responsible for goods damaged during shipping. BakeMax is not responsible for any delays in delivery once product has left our Warehouse and is in the carrier's possession. Products shipped are to be inspected at time of delivery, the receiver is responsible for inspection. Damaged Freight Claims are to be claimed with the carrier. BakeMax assumes no responsibility for Damaged Freight. Shipping Insurance available by request. By signing your name on the delivery receipt without noting any damages, you are stating that you have received your shipment in Acceptable Condition.

Return Policy

Returns will not be Approved unless in Writing. Returns must be made within 30-Days of Purchase and must have a Return Authorization Number issued before returning. The purchase order number, reason for return, and the serial number(s) of the unit are required for the Return Authorization Number. Minimum return amount of \$100.00.

Returns are subject to a minimum restocking fee of 30%. The cost of any repairs or re-crating required will be charged back to the dealer. If there is a manufacturer's defect BakeMax® will pay standard freight returned and prepaid shipping back to the customer.

Special Order Items, Clearance / Discontinued Equipment, Parts, Refurbished/Demo Equipment, or Non-Standard items are not Returnable.

Ordering Information

Send purchase orders to BakeMax via e-mail orderdesk@bakemax.com or Fax (506-859-6929). Use Model or Part number when ordering including Voltage Requirements, and Product Description. Please include the Dealer, Name, Address, terms, special delivery, or instructions required or attention names to be applied to packaging. Please notify BakeMax should you need order confirmation or tracking numbers, by calling 1-800-565-2253 or email orderdesk@bakemax.com.

Special Terms and Conditions

BakeMax reserves the right to make improvements or equipment changes without prior permission. Setup and Installation are the end user's Responsibility. Failure to properly Install or Maintain Equipment may Void Warranty.

Catalog, Spec Sheets and Website

BakeMax is not liable for incorrect information found in our Catalog, Spec Sheets or Website. Please contact us to confirm specifications. Pictures and specifications are for general purposes only. Product may not be exactly as shown. Prices and availability may change at any time without notice. Dimensions shown may change at any time without notice.

Due to continuous product improvement, specifications are subject to change without notice.

Visit www.BakeMax.com for up-to-date product information.

1-800-565-2253

OrderDesk@BakeMax.com

BakeMax[®]

www.BakeMax.com



USA Warehouses

5705 Valley Belt Rd
Independence, OH 44131

1201 E 27th Terrace
Pittsburg, KS 66762

Head Office & Canadian Warehouse

Titan Ventures International
20 Caribou St
Moncton, NB E1H 0P3

Contact Information

Phone: 1-800-565-BAKE (2253)
Sales: Sales@BakeMax.com
Orders: OrderDesk@BakeMax.com
Service: Service@BakeMax.com
Parts: Info@BakeMax.com
Fax: 1-506-859-6929

© Titan Ventures International Inc. (TVI) 2024. All Rights Reserved.
BakeMax is a Registered Trademark of (TVI) Titan Ventures International Inc.