



America

www.BakeMax.com

Project: \_\_\_\_\_

Item: \_\_\_\_\_

Qty: \_\_\_\_\_ Date: \_\_\_\_\_

# BakeMax America BASCO5 & BADCO5 Convection Oven

The BakeMax America Convection Ovens are built to last and can accommodate holding 12 full size bakery pans at 1.5" spacing. It can cook a variety of foods and is widely adjustable to meet the customer's needs. The electric model features a 11000W Heating Element, and the Gas Model has four burners at 50,000 BTU per burner, allowing food to be cooked quickly and efficiently. Ideal for Hotels, Restaurants and Bakeries.



Models  
BASCO5G  
BASCO5E

### Features:

- Hygienic & Easy-to-Clean Stainless-Steel Construction
- Heavy-Duty Removeable Stainless-Steel Front Door with Double Glass Front Window for Ease of Cleaning
- Enameled Oven Cavity has rounded corners for better heat circulation and features twelve removeable rack supports at 1.5" spacing, includes 5 racks per oven
- Interior Long-Lasting Halogen Lights
- Integrated Safety System that shuts off power to the fan when either of the doors are opened
- Digital Timer can go up to 999 Minutes.
- Solid State Thermostat with a Temperature Range of 150-500°F (65-260°C)
- Forced Air Circulation System accountable for evenly baking food and maximizing efficiency for energy savings
- 3/4 HP Two-Speed (1125 and 1725 RPM) Blower Motor with Reversible Rotation
- Heat Element & Gas Shut-Off Switch on Front Panel
- Two Auxiliary Cooking Features: Hold & Pulse
- 2-Year Limited Warranty



### Technical Specifications

Model	Width	Depth	Height	Racks	BTU NG	BTU LP	Electrical	Oven Cavity Dims (W x D x H)
BASCO5G	38"	46.6"	61.6"	5	200,000	200,000	240V / 4.5A 720W / 1Ph	25.5" x 29" x 20"
BASCO5E	38"	46.6"	61.6"	5	240V / 1Ph / 60HZ / 11000W / 51A			25.5" x 29" x 20"
BADCO5G	38"	46.6"	71.4"	10	400,000	400,000	240V / 9A 1440W / 1Ph	25.5" x 29" x 20"
BADCO5E	38"	46.6"	71.4"	10	240V / 1PH / 60HZ / 22000W / 102A			25.5" x 29" x 20"

\*\* Due to continuous product improvement, specifications are subject to change without notice.

**BakeMax® / Titan Ventures International Inc.**

#### Warehouses:

20 Caribou St, Moncton, NB E1H 0P3   
5705 Valley Belt Rd Independence, OH 44131   
1201 E 27th Terrace Pittsburg, KS 66762

**Toll Free:** 1-800-565-BAKE (2253)   
**Phone:** 506-858-8990   
**Fax:** 506- 859-6929   
**Email:** Sales@BakeMax.com

### BakeMax America BASCO5 & BADCO5 Convection Oven

The BakeMax America BADCO5 series convection oven comes with the same features of the BASCO5 Series, only with another oven stacked on top. With its space saving design, it is developed with our customers in mind and capability of holding 24 full size pans at 1.5" spacing.



Model #'s  
BADCO5G  
BADCO5E

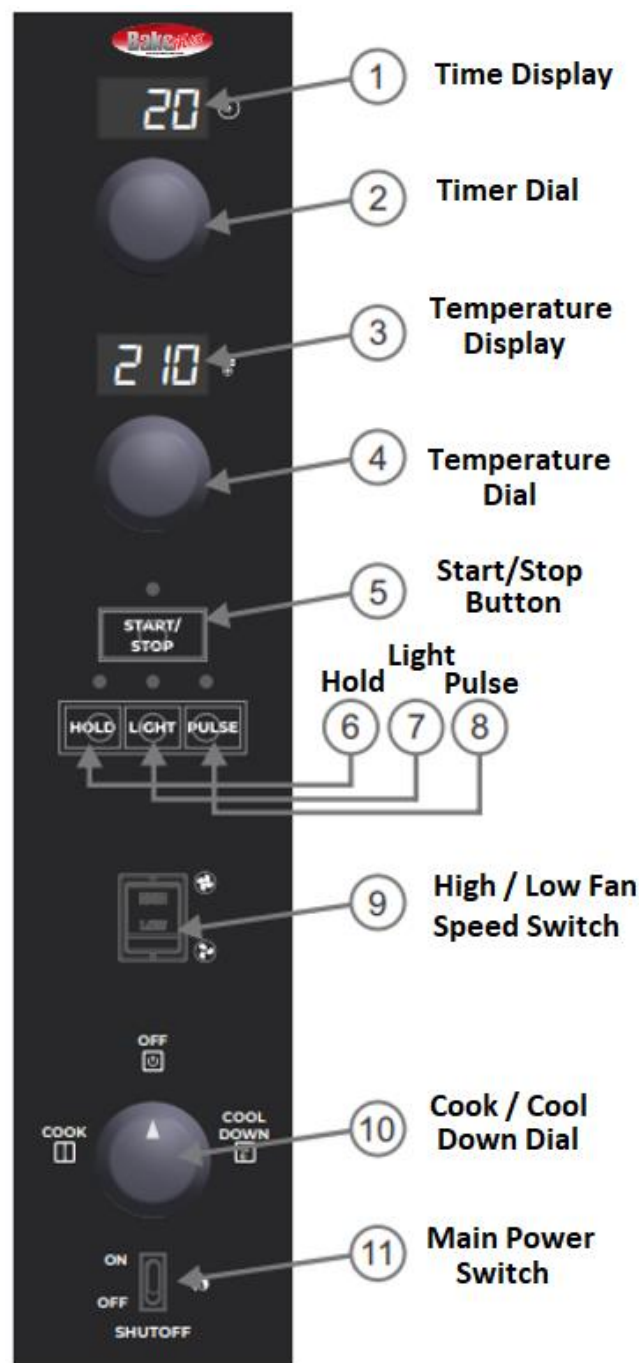

#### Shipping Specifications

Model	Net Weight	Crated Weight	Crated Dimensions (W x D x H)
BASCO5G	492 lb.	538 lb.	43.3 x 52" x 39.4"
BASCO5E	463 lb.	509 lb.	43.3" x 55" x 39.4"
BADCO5G	913 lb.	1014 lb.	43.4" x 49.3" x 77.6"
BADCO5E	885 lb.	985 lb.	43.4" x 49.3" x 77.6"



BakeMax<sup>®</sup> / Titan Ventures International Inc.

#### Warehouses:

20 Caribou St, Moncton, NB E1H 0P3   
 5705 Valley Belt Rd Independence, OH 44131   
 1201 E 27th Terrace Pittsburg, KS 66762 

Toll Free: 1-800-565-BAKE (2253)  
 Phone: 506-858-8990  
 Fax: 506- 859-6929  
 Email: Sales@BakeMax.com

### BakeMax America BASCO5 & BADCO5 Convection Oven

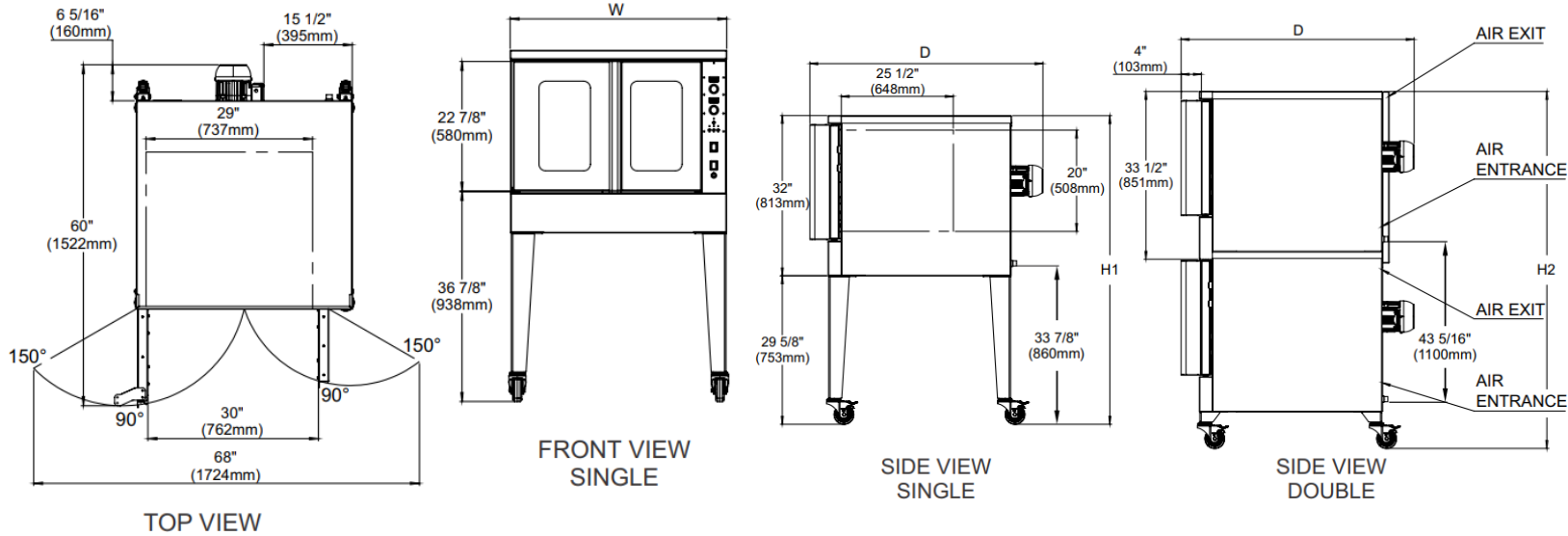

Model	Exterior Product Dimensions & Weight					Oven Cavity (per deck)		
	Width (W)	Depth (D)	Height (H1)	Height (H2)	Weight	Width	Depth	Height
<b>BASCO5 Base deck</b>	38" (965 mm)	46 5/8" (1184 mm)	61 5/8" (1566 mm)	-	463 lbs (210 kg)	29" (737 mm)	25 1/2" (648 mm)	20" (508 mm)
<b>BASCO5 Single deck</b>								
<b>BADCO5 Double deck</b>				71 3/8" (1812mm)	884 lbs (401 kg)			

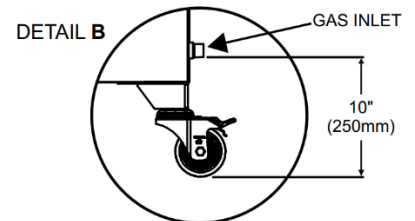
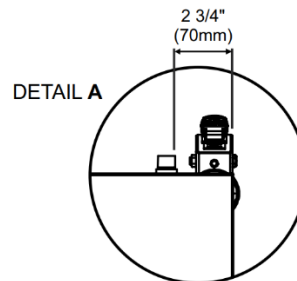

Model	Shipping Crate Dimensions & Weight			
	Width	Depth	Height	Weight
<b>BASCO5 Base deck</b>	43 5/16" (1100 mm)	52" (1320 mm)	39 3/8" (1000 mm)	509 lbs (231 kg)
<b>BASCO5 Single deck</b>				
<b>BADCO5 Double deck</b>		49 1/4" (1250 mm)	77 9/16" (1970 mm)	985 lbs (447 kg)



\*\* Due to continuous product improvement, specifications are subject to change without notice.

**BakeMax® / Titan Ventures International Inc.**

**Warehouses:**

20 Caribou St, Moncton, NB E1H 0P3   
 5705 Valley Belt Rd Independence, OH 44131   
 1201 E 27th Terrace Pittsburg, KS 66762 

**Toll Free:** 1-800-565-BAKE (2253)  
**Phone:** 506-858-8990  
**Fax:** 506- 859-6929  
**Email:** Sales@BakeMax.com