

## BakeMax BMGG019 Floor Model Refrigerated Display Case



**Questions? Contact Us:**

Toll Free: 1-800-565-2253

Email: [Info@BakeMax.com](mailto:Info@BakeMax.com)

[www.BakeMax.com](http://www.BakeMax.com)



## WARNING: PLEASE READ AND FOLLOW THE INSTRUCTIONS BELOW BEFORE OPERATING PRODUCT

- When using the machine, please confirm that you have read all the instructions within this manual.
- Beware of any child/children or any other persons who are near the machine before operating.
- Do not put hand near moving parts.
- Remove all obstacles, which may interfere with machine functions.
- Keep work area clean and clear of clutter.
- Do not sit or stand on machine
- Do not wear loose cloth or jewellery when operating machine as it may get caught in moving parts and cause injury
- When the machine is abnormal or broken, you should stop using and check it or have it checked by a professional.
- Disconnect from power source before performing maintenance on the machine.
- When machine is not in use, please clean and store properly.
- Do not place any electrical parts or plug/cord in water.
- The cord should be away from the heat.
- Don't hang out the cord on the desk or cabinet.
- Machine may have sharp or pointed edges, use caution when cleaning.
- This machine should only be operated by personnel who can read, understand and respect warnings and instructions regarding this machine and the manual.
- Keep this manual in a safe place for further and regular reference and ordering parts.
- Please write model serial and date of purchase of your machine in the space provided in case you will need to order parts in the future.
- Always work by security code of your country, state, province, city or committee of your work place.

Thank you for choosing and purchasing our product. Please carefully read the operation instructions before use for a correct application and satisfactory effect.

## Note

1. The electric circuit diagram and parameters on the product name plate are final ones if they have been changed.
2. The design might be improved without notice.
3. If the supply cord is damaged, it must be replaced by the manufacturer, its service agent or similarly qualified persons in order to avoid a hazard.



### WARNING:

Refrigerant is facility burning of R290, please protect against fire.



### Meaning of crossed out wheeled dustbin:

Do not dispose of electrical appliances as unsorted municipal waste, use separate collection facilities. Contact your local government for information regarding the collection systems available.

If electrical appliances are disposed of in landfills or dumps, hazardous substances can leak into the groundwater and get into the food chain, damaging your health and well-being.

When replacing old appliances with new ones, the retailer is legally obligated to take back your old appliance for disposals at least free of charge.

## General

This product is a type of chilling cabinet, which is our new development of refrigeration combining the advanced technologies from both and abroad on the basis of food cabinet standards and corporate criteria. Its main kits and key components are all good brands, either and streamlined design, the product integrates the actual market demand in structural design, which better cater to the ergonomics requirements of consumers. This series applies mainly to displaying and selling of drinks, dairy products, vegetables and fruits.

Parameter	Model	BMGG019
Coolant and injection quantity(g)		R404a(340)
General Rated input power(W)		1230
Power running of electrical heating element(W)		450-536
Max.ambienttemp./RH		<27°C(80.6°F)/70%
Refrigeration temperature(°C)(°F)		2-10(35.6-50)
Rated voltage(V~)		110-120
Rated Frequency(Hz)		60
Rated Current(A)		11.2
Type of Climate		6
Net weight(kg)		96
Lamp power(W)		1.44*4(LED)
Total effective volume(L)		220
Overall dimension (mm) (LxWxH)		494x674x1742
Foaming agent		Cyclopentane

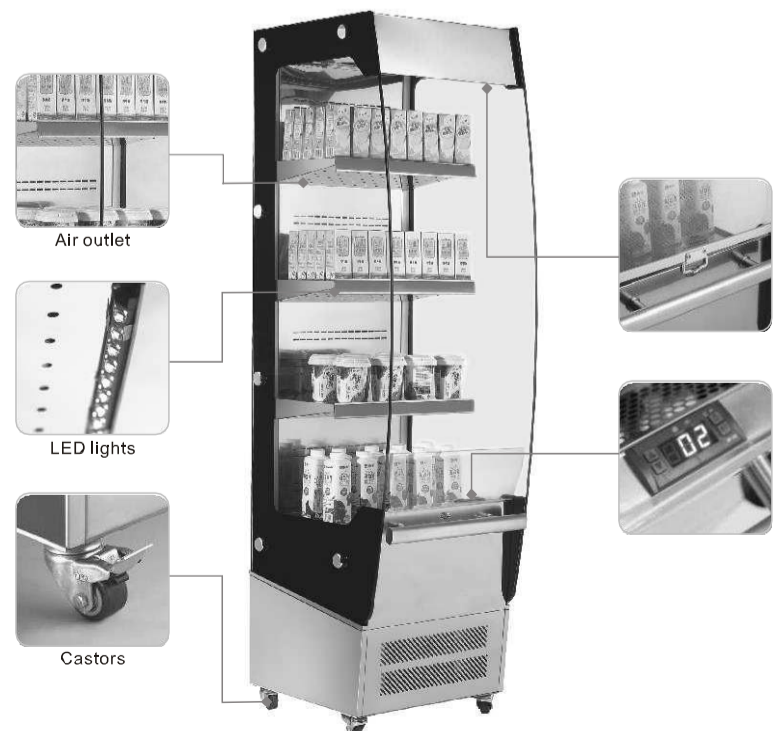

### Handle with care

Unplug the wall socket first.  
Never tilt it over 45 degree during handling.



### Dry place

Always locate the refrigerator at a dry place.



### Sufficient space

The distance from both sides and back of refrigerator to wall or other substance must not less than 10cm. The refrigeration capability might be decreased if its surround space is too small to circulate air.

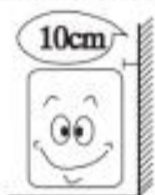

### Well ventilation

Always locate the refrigerator at a place with fine ventilation. For the first time use, wait for 2 hours after handling and then plug the wall socket and start it.



### Far from heat source

Never place the refrigerator directly under the sunshine. Never locate it nearby any heat source or heater to prevent it from reducing refrigeration capability.



### No heavy load

Never put any heavy load on the top of the refrigerator.



### No hole making

Never make hole on the refrigerator. Never install other matter on the refrigerator.

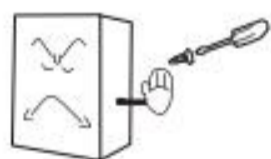

### Stable location

To avoid the unexpected noise and vibration, Unpacking and locate the refrigerator on a flat and solid place.



### Exclusive power socket

Normally, the power supply should be 110-120V,60Hz single phase AC with exclusive single phase three pin receptacle.



### No share on socket

Never let the refrigerator share the common socket with other appliance, otherwise the cable becomes hot, and fire might be resulted



### Protect cables

Never break or damage the cables otherwise current leakage and fire might be resulted.

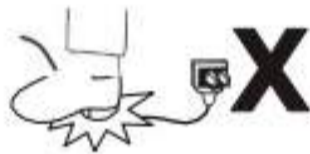

### No water flushing

Never give the refrigerator surfaces a flush otherwise current leakage might be resulted.



### Prevent from flammables and explosive

Never put any flammable or explosive inside the refrigerator such as ether, gasoline, alcohol, adhesive and explosive. Never put dangerous product nearby the refrigerator.

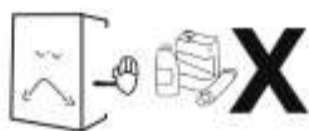

### No spray

To spray the flammables such as paint or coating nearby the refrigerator is not allowed, otherwise fire might be resulted.



### After power break

After power break or unplugging the refrigerator, always wait at least 5 minutes and then you may plug the refrigerator and start it again.

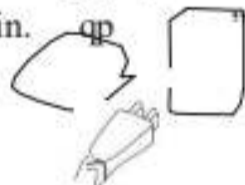

### No medicine

No medicine is allowed to keep inside the refrigerator.



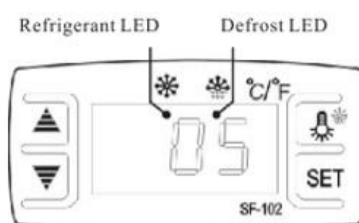

### Features Of Function

- It is a mini-sized and integrated intelligent controller and applicable to the compressor of one Hp.
- The main functions are: Temperature Display/ Temperature control/Manual, automatic defrost by burning off/Illumination Control/Value Storing/self Testing/parameter Locking.

### Front Panel Operation

1. Set temperature  
Press button, the set temperature is displayed.  
Press or button to modify and store the displayed value,  
Press button to exit the adjustment and display the cold-room temperature.
2. If no more button is pressed within 10 seconds, the cold-room temperature will be displayed.
3. Illumination: Press button, it lights; Press again, it stops.  
Manual start/stop defrost: Press button and hold for 6 seconds to defrost or stop defrost.
4. Refrigerant LED: During refrigeration, the LED is on; When the cold room temp. is constant, the LED is off; During the delay start, the LED flashes.
5. Defrost LED: during defrosting, the LED is on; When it stops defrosting, the LED is off, During the delay display of defrost, the LED flashes.
6. Digital controller reset  
When display shows "Disorder", press "" button for 2s until buzzer rings, quickly press "" button for 6s until buzzer rings again, the display will flash for 3s and it restores factory setting.

### To Unlock the Controller Parameters

Press the Down Arrow for 10 seconds or until the display shows "ON"

If it shows "OFF", leave it for 10 seconds, then press the Down Arrow again for 10 seconds, then it will show "ON"

### To Check Evaporator Temperature

Press the UP Arrow for 10 seconds, and the evaporator temperature will be displayed.

### To Change Parameters:

Press "SET" for 6s (Order: E1, E2, E3, E4, E5, E6, F1, F2, F3, F4, C1)  
Quickly Press "SET" again to change the parameter you wish to change.

## BakeMax Parameters

### Lower Set Point Limit (Fahrenheit)

Press "SET" until display flashes "E1".

Press the "UP" or "Down" arrow to adjust setting to **32°F / 0°C**.

### Raise Set Point Limit (Fahrenheit)

Press "SET" until display flashes "E2".

Press the "UP" or "Down" arrow to adjust setting to **50°F / 10°C**.

### Temp. Hysteresis

Press "SET" until display flashes "E3".

Press the "UP" or "Down" arrow to adjust setting to **2**.

## Compressor Start Delay Time

Press “SET” until display flashes “E4”.

Press the “UP” or “Down” arrow to adjust setting to **0**.

## Offset On Room Temp.

Press “SET” until display flashes “E5”.

Press the “UP” or “Down” arrow to adjust setting to **0**.

## Offset On Evap. Temp.

Press “SET” until display flashes “E6”.

Press the “UP” or “Down” arrow to adjust setting to **0**.

## Max Defrost Duration \*This is the duration of the defrost (melting cycle)

Press “SET” until display flashes “F1”.

Press the “UP” or “Down” arrow to adjust setting to **20 Minutes**.

## Defrost Interval Time

Press “SET” until display flashes “F2”.

Press the “UP” or “Down” arrow to adjust setting to **2 Hours**.

## Defrost Termination Temperature

Press “SET” until display flashes “F3”.

Press the “UP” or “Down” arrow to adjust setting to **59°F**. (15°C / 59°F)

## Display During Defrost

Press “SET” until display flashes “F4”.

Press the “UP” or “Down” arrow to adjust setting to 00.

## Temperature Units (C to F or F to C)

Press “SET” again, so you can change mode from E1 to C1.

C1 Settings: 00 = Celsius , 01 = Fahrenheit

**To confirm parameters, do not press any buttons for 10 seconds, until the temperature is displayed.**

The principle of compression refrigeration consists of "compression", "condensation", "throttling" and "vaporization". The compression is undertaken by compressor, the condensation is completed by condenser, the throttling is executed by capillary and the vaporization is implemented by evaporator. When the coolant is circulating in the closed refrigeration system, the compressor sucks coolant, which has absorbed heat in evaporator, the coolant becomes a high pressure and high temperature gas. In condenser, it dissipates heat in air, while the coolant is re-liquefied and throttled in capillary and then enters into evaporator with low pressure. The liquefied coolant quickly boils and vaporizes into gas when the pressure suddenly drops. Meanwhile, it absorbs heat inside the refrigerator. And the compressor sucks the low pressure and low temperature gaseous coolant,.....It is circulating in this way up to realization of intended refrigeration.

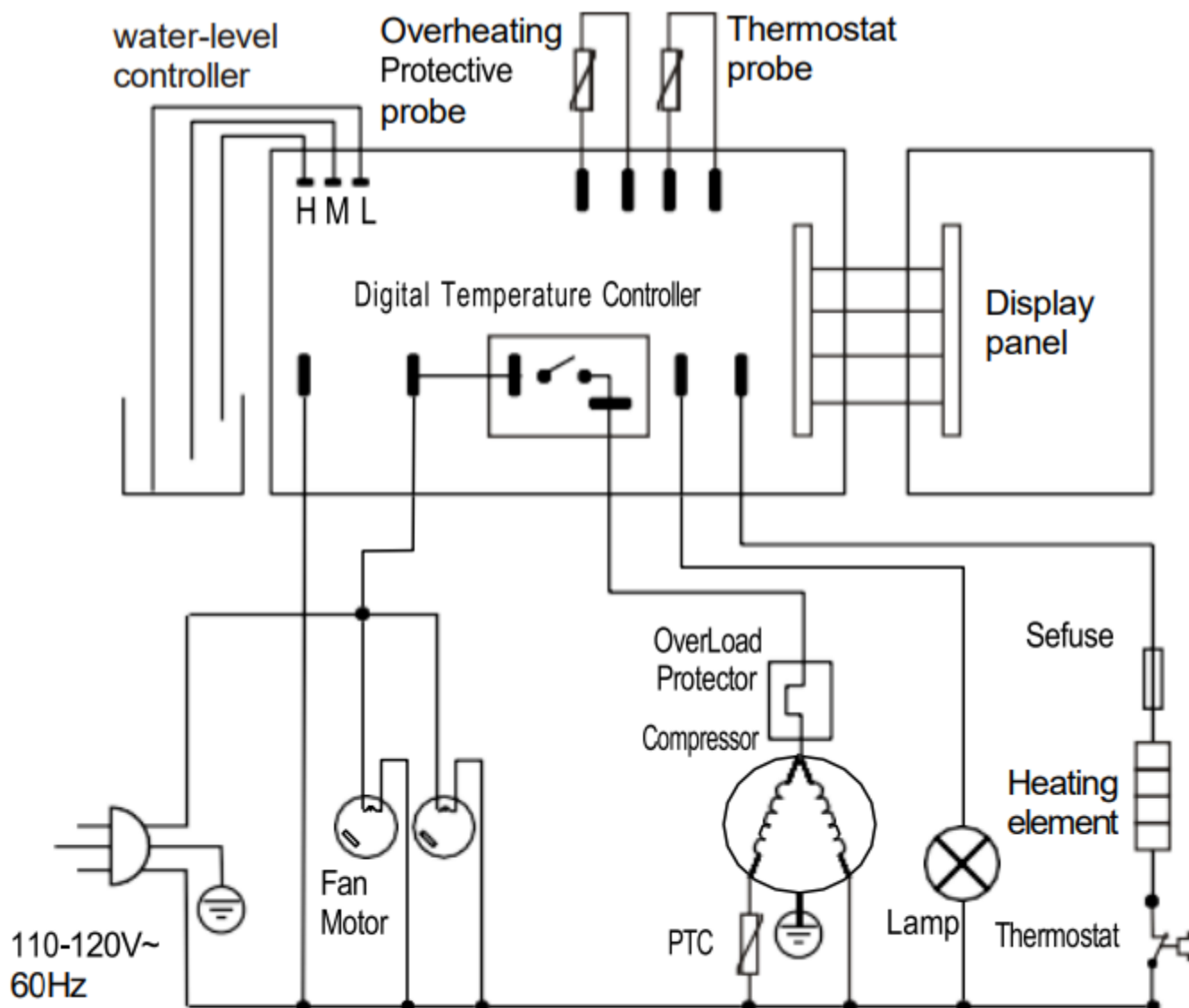
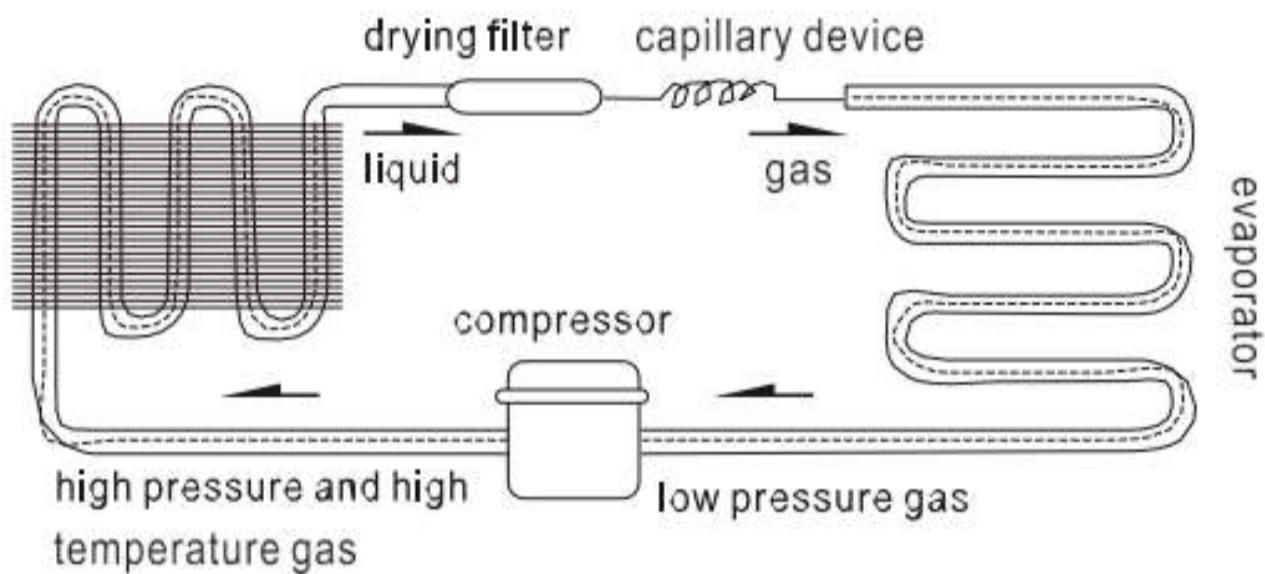



# Warranty & Service

BakeMax provides a 1-Year Limited Parts and Labor warranty on most items, there are select items which carry a Limited 2-Year Warranty. Extended Warranty is available on some products. Please contact us for details. The Warranty is not transferable and is limited to original installation of equipment sold by BakeMax for the original user.

For all Warranty Claims, Proof of Purchase and/or Serial Number is required. Once the machine is approved, BakeMax will provide our customers with on-site Warranty Coverage on all equipment more than 100lbs. BakeMax assumes no responsibility for down time or loss of product. Repairs must be Pre-Authorized by BakeMax and have a Service Authorization Number issued prior to commencing Warranty Service.

Warranty begins 10-Days after shipping from warehouse; delays in installation which would extend the Warranty must be Approved. All equipment must be installed and connected by Qualified Professionals in accordance with the Manual Specification. Products shipped are to be inspected at time of delivery, the receiver is responsible for inspection.

Any abuse or improper use of the equipment will void the warranty. This includes failure to follow all cleaning instructions, improper installation, improper maintenance, failure to follow capacity charts, improperly wired electrical connections. The Warranty does not apply to abuse, willful or accidental damage, or to products used for other than their intended purpose. Normal wear parts such as Accessories, Attachments, or Electrical Components such as Fuses, Bulbs, Elements, and Switches carry a 90-Day Warranty only.

Bench Warranty (Machines Weighing 100 lb. or less)

Once the machine is Approved for Warranty Service, if the machine requires Warranty work in less than 30 days of purchase date, BakeMax will pay all shipping charges. Once the machine is received and repaired it will be returned to the user at BakeMax expense. Freight Damages during return shipping is the responsibility of the owner of the machine.

The following is not covered under the BakeMax Warranty:

1. Overtime Labor Rates are not covered by BakeMax.
2. All parts will be shipped via Ground Courier only; If Express Shipping is required, it will be the responsibility of the Customer or Dealer.
3. Travel for Warranty Service is covered up to 100 Miles /160 Km Roundtrip, any further milage will be the responsibility of the Customer or Dealer.
4. There is no on-site Warranty Service for Residential Addresses or addresses outside of the contiguous United States (*Lower 48*) or Canada.

*\*\*BakeMax machines sold outside of the contiguous United States (Lower 48), or Canada will carry 1-Year Parts Warranty only.*

# Terms & Conditions

## Terms

Net 15 days subject to Credit Approval. All past due Accounts are subject to 2% per month Service Charge as per Credit Application. We accept Visa, MasterCard, and Discover Credit Cards. We also accept E-Transfer & Wire Transfer, additional fees may apply.

## Pricing

All prices are subject to change without notice. All prices are Sales Tax Extra, should you be claiming Tax Exemption, Tax Exempt Forms must accompany your Purchase Order. BakeMax products are sold in Canadian and US Dollars. BakeMax is not responsible for specifications errors or printing errors.

## Shipping

Free shipping to Canada and the U.S. Minimum order \$6,000 for BakeMax and \$10,000 for BakeMax America Cooking Line. Tailgate Delivery is \$90.00 minimum. All checks made Payable to Titan Ventures International Inc. BakeMax is not responsible for goods damaged during shipping. BakeMax is not responsible for any delays in delivery once product has left our Warehouse and is in the carrier's possession. Products shipped are to be inspected at time of delivery, the receiver is responsible for inspection. Damaged Freight Claims are to be claimed with the carrier. BakeMax assumes no responsibility for Damaged Freight. Shipping Insurance available by request. By signing your name on the delivery receipt without noting any damages, you are stating that you have received your shipment in Acceptable Condition.

## Return Policy

Returns will not be Approved unless in Writing. Returns must be made within 30-Days of Purchase and must have a Return Authorization Number issued before returning. The purchase order number, reason for return, and the serial number(s) of the unit are required for the Return Authorization Number. Minimum return amount of \$100.00.

Returns are subject to a minimum restocking fee of 30%. The cost of any repairs or re-crating required will be charged back to the dealer. If there is a manufacturer's defect BakeMax® will pay standard freight returned and prepaid shipping back to the customer.

Special Order Items, Clearance / Discontinued Equipment, Parts, Refurbished/Demo Equipment, or Non-Standard items are not Returnable.

## Ordering Information

Send purchase orders to BakeMax via e-mail [orderdesk@bakemax.com](mailto:orderdesk@bakemax.com) or Fax (506-859-6929). Use Model or Part number when ordering including Voltage Requirements, and Product Description. Please include the Dealer, Name, Address, terms, special delivery, or instructions required or attention names to be applied to packaging. Please notify BakeMax should you need order confirmation or tracking numbers, by calling 1-800-565-2253 or email [orderdesk@bakemax.com](mailto:orderdesk@bakemax.com).

## Special Terms and Conditions

BakeMax reserves the right to make improvements or equipment changes without prior permission. Setup and Installation are the end user's Responsibility. Failure to properly Install or Maintain Equipment may Void Warranty.

## Catalog, Spec Sheets and Website

BakeMax is not liable for incorrect information found in our Catalog, Spec Sheets or Website. Please contact us to confirm specifications. Pictures and specifications are for general purposes only. Product may not be exactly as shown. Prices and availability may change at any time without