

BakeMax BMPLS7KE020

4-Burner

Electric Hot Plate



Questions? OEM Parts?

Toll Free: 1-800-565-2253

Email: Service@BakeMax.com

www.BakeMax.com



Warning & Safety

PLEASE READ AND FOLLOW INSTRUCTIONS BELOW TO PREVENT INJURY OR DAMAGE TO THE PRODUCT

BakeMax® (a registered trademark of Titan Ventures International Inc or TVI) is not responsible for any harm or injury caused due to any person's improper or negligent use of this equipment. The product shall only be operated by someone over the age of 18, of sound mind, and not under the influence of any drugs or alcohol, who has been trained in the correct operation of this machine, and is wearing authorized, proper safety clothing. This machine is intended for commercial use only. Any modification or miss use to the machine voids any warranty and may cause harm to individuals using the machine or around the machine while in operation.

- When using the machine, please ensure that you have read all the instructions within this manual.
- Be aware of your surroundings when using this machine, ensure there are no children or any other persons who are near the machine before operating.
- Do not put hand near moving parts.
- Remove all obstacles, which may interfere with machine functions.
- Keep work area clean and clear of clutter.
- Do not sit or stand on machine.
- Do not wear loose clothing or jewelry when operating machine as it may get caught in moving parts and cause injury.
- Stop using the machine and have it checked by an authorized service personal if it is not working properly.
- Disconnect from power source before performing and maintenance or cleaning on the machine.
- When the machine is not in use, please clean and store properly,
- Do not place any electrical parts or plug / cord in water or liquid.
- If the supply cord is damaged it must be replaced by an authorized service agent to avoid any electrical hazards.
- Keep power cord away from heat.
- Always ensure to follow local laws when operating your machine.

GENERAL INFORMATION

Before installing the appliance, read operation and maintenance instructions carefully. Wrong installation and part changing may damage the product or may cause injury on people. These are not in our company's responsibility to damage the appliance intentionally, negligence, detriments because of disobeying instructions and regulations, wrong connections, un-authorized intervention to appliance invalidates the warranty.

1. This instruction manual should be kept in a safe place for future reference.
2. **Installation should be made in accordance with ordinances and security rules of that country by qualified service personnel.**
3. This appliance must be used by a trained person.
4. Please turn off the appliance immediately in the event of malfunction or failure. The appliance should be repaired only by authorized service personnel. Please demand original spare part.

WARNING:

- This device must be installed in accordance with applicable legislation and should only be used in a well-ventilated area. Please refer to the instructions before installing and using this device.
- Improper installation, adjustment, modification, service or maintenance can result in property damage, injury or death. Read the installation, use and maintenance instructions before installing or servicing this equipment.

SAFETY SYMBOLS



These symbols are intended to alert the user to the presence of important operating and maintenance instructions in the manual accompanying the appliance.

SERVICE AND MAINTENANCE / MAINTENANCE AND REPAIRS

Contact your local authorized service agent for service or required maintenance.

Please record the model number, serial number, voltage and purchase date in the area below and have it ready when you call to ensure a faster service.

Model No.	BMPLS7KE020
Serial No.	
Voltage	
Purchase Date	

Authorized Service Agent Listing Reference the listing provided with the unit or for an updated listing go to:

Website: www.BakeMax.com

E-mail: Service@BakeMax.com

Service Help Desk	
Company	BakeMax
Website	www.BakeMax.com
Phone	(800) 565-2253
Fax	(506) 859-6929
Address	20 Caribou St, Moncton, NB E1H 0P3

PRODUCT DESCRIPTION

*The Professional Electric Hot Plate, that provides high efficiency has been designed to be used in industrial kitchens.

Model #	Electrical	Width	Depth	Height	Product Weight	Crated Weight
BMPLS7KE020	208V / 38.5 A / 8000W / 1Ph 208V / 22.5A / 8000W / 3Ph	307mm 24.09"	885mm 34.85"	363mm 14.29"	38kg 84lbs.	52kg 115lbs.

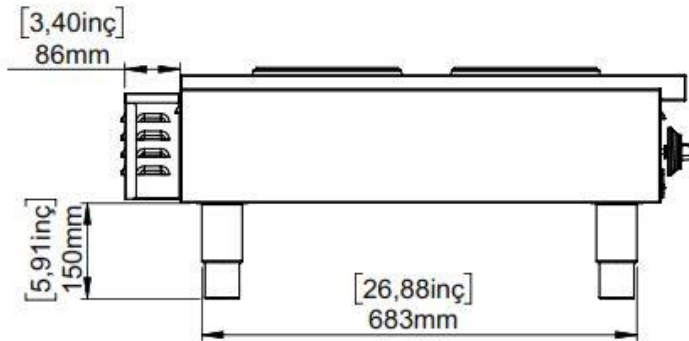
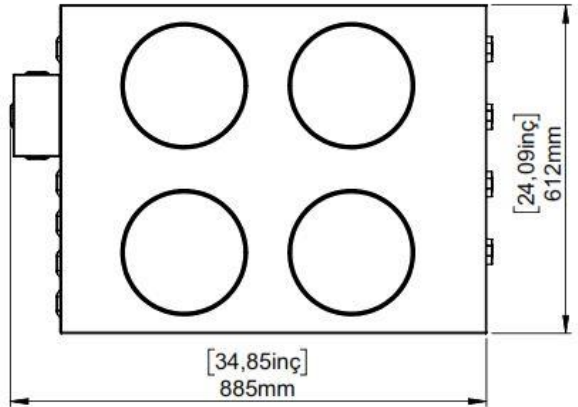
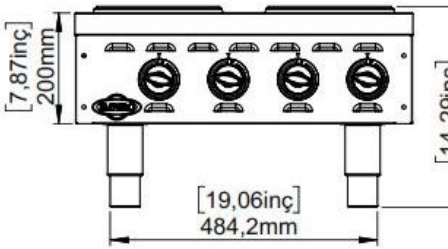

INSTALLATION

*Please place the product to straight and sturdy ground, please take necessary steps against possibility of overturn.

*Technician who will serve for installation and service for the appliance must be professional on this subject and must have installation and service licenses by the company.

*Connection to Electric Power Supply must be done by authorized person.



*Please be sure that the voltage connected to appliance must be equal with the voltage which is on appliance's label.

 This appliance must be connected to an earthed outlet in accordance with safety rules and standards.









*Appliance's earthing must be connected to earthing line on panel which is nearest to electric installation.

*Connection to the main fuse and leak current fuse must be done in accordance with the current regulations.

*If the location where electric ranges placed is covered with nonflammable heat insulation material, the distance between them must be 5 cm. Otherwise it should be at least 20 cm. The appliance shouldn't be operated under chimney hood.

-  a) Adequate means must be provided to limit the movement of the appliance without depending on or transmitting stress to the electrical conduit;
-  b) Restraint device is located on the back side of appliance.
-  c) The appliance shall be installed using flexible conduit.

SAFETY INSTRUCTIONS

-  *Do not use the appliance in insufficient lighted place.
-  *Do not touch the moving attachments while the appliance operates.
-  *Do not install the appliance in the presence of flammable or explosive materials.
-  *Do not operate the appliance when the machine is empty.
-  *Do not load so less or more than appliance's capacity.
-  *Do not attempt to use the appliance without suitable protective equipments.
-  *Because of any reason if there is a fire or flame flare where the appliance is used, turn off all gas valves and electric contactor switch quickly and use fire extinguisher. Never use water to extinguish the fire.
-  *All the damages because of not having earthing connection will not be on warranty.

OPERATION

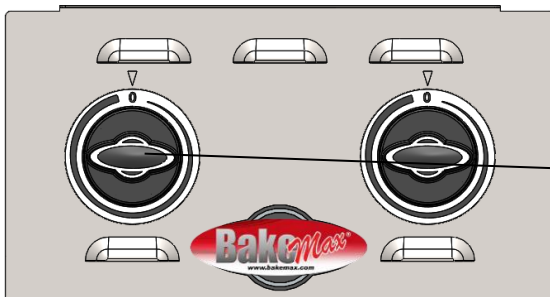

A : Heat Adjustment Knob

OPERATING INSTRUCTIONS:

- Plug in the appliance.
- Put the pan on the hot plate burner.
- Adjust heat setting buttons to desired temperature.
- The range reaches the desired temperature and starts to operate.
- After operation is completed, switch heat setting buttons to (0) position and unplug the appliance.

CLEANING & MAINTENANCE

CLEANING AND MAINTENANCE AFTER EVERY USE

- Always turn off the appliance and disconnect from the power supply before cleaning. Clean the outer surface of the appliance with a wet cloth and chrome shiner.
- Do not use abrasive cleaning chemicals as these can leave harmful residues.
- Do not clean the appliance by spraying water directly, otherwise electric motor may get damaged.

PERIODIC CLEANING AND MAINTENANCE

- Maintenance should be done by qualified person.
- Get the periodic maintenance of the appliance once in every 15 days.
- Check the heater's electric connection in periodic times.
- Maintenance of the appliance's contactor should be done by compressed air

TROUBLESHOOTING

THE APPLIANCE DOESN'T OPERATE

1. Check if the appliance is plugged in.
2. Check the electrical connections and voltage.

THE APPLIANCE DOESN'T COOK WELL

1. Check if it is operated at required heat or not.

THE APPLIANCE STOPPED

1. The appliance can stop due to low voltage. In this situation check the voltage.
2. When the plates get too hot, they protect themselves and can be operated again after they cool down.

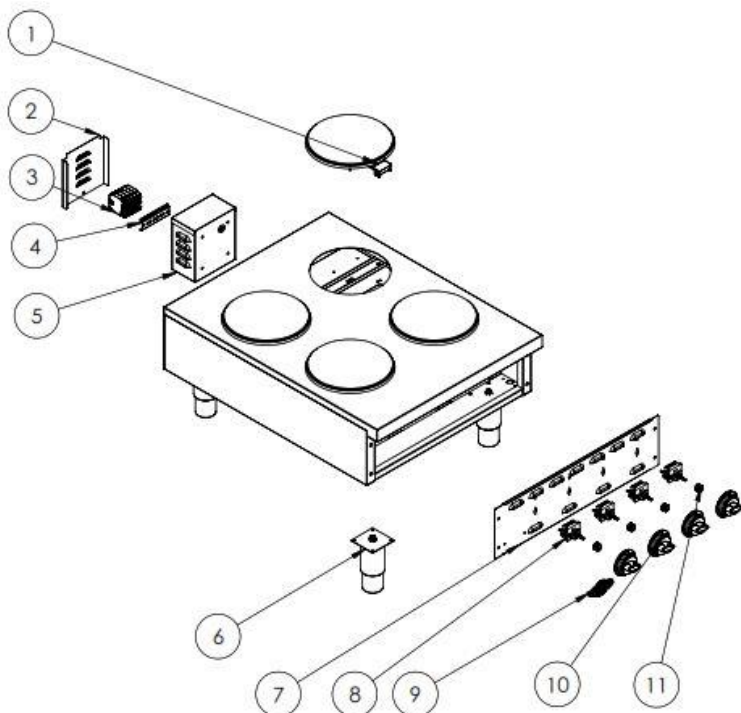

#	Part Description	Factory #
1	HOTPLATE 2 KW Q220 208V 4 OUTLET TERMINAL BLOCK-UL	M.ELK-HOT-YHT-017
2	EMP.PLS.7IE040-UL-TRAFO COVER SC	YSC-KNX.PG7-PN-0941
3	AVK 10x10 MM RAIL FLANGE (BLUE)	M.ELK-KLM-038
4	VENDING MACHINE RAIL (10CM)	YEL-ERS.PR-KS-0001
5	EMP.PLS.7IE040-UL-TRAFO SC	YSC-KNX.PG7-PN-0940
6	13 CM CHROME PIPE FOOT ASSEMBLY-1	M.AKS-AYK-INX-001
7	EMP.PLS.7KE020-UL SET-TOP FRONT PANEL	YSC-KNX.PG7-LZ-1353
8	ENERGY REGULATOR	M.ELK-MEK-TRM1-032
9	EMPERO EMBOSSED METAL LABEL (PLUS)	M.AKS-OZL-MTL-006
10	EMP BUTTON 0-6 PRINTED	M.AKS-DGM-EMP-010
11	FAUCET BUTTON SOCKET 6 MM ELK Ü.	M.AKS-DGM-SKT-002

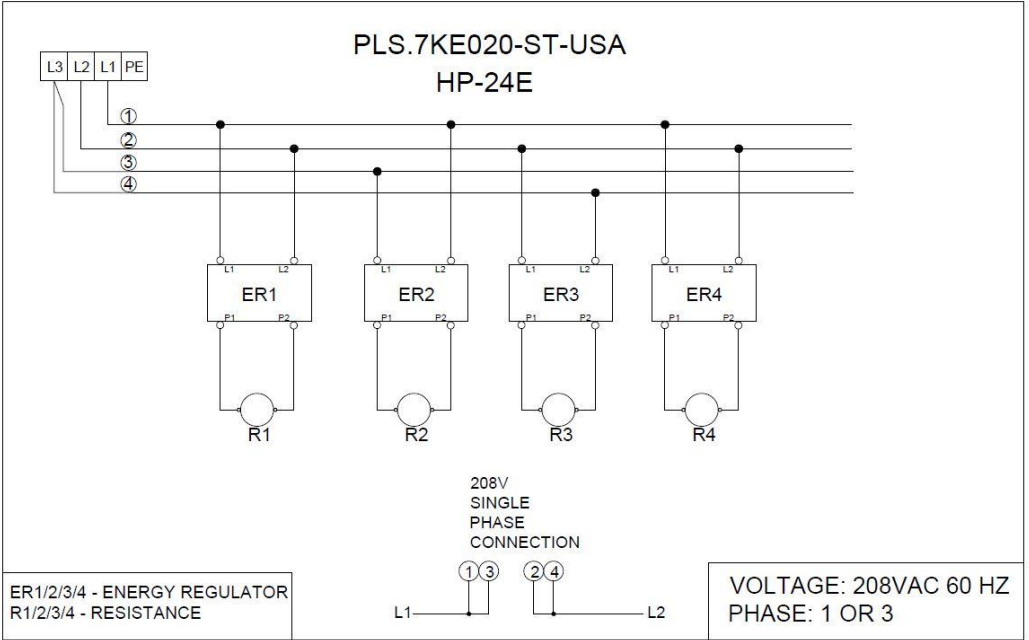

Warranty & Service

BakeMax provides a 1-Year Limited Parts and Labor warranty on most items, there are select items which carry a Limited 2-Year Warranty. Extended Warranty is available on some products. Please contact us for details. The Warranty is not transferable and is limited to original installation of equipment sold by BakeMax for the original user.

For all Warranty Claims, Proof of Purchase and/or Serial Number is required. Once the machine is approved, BakeMax will provide our customers with on-site Warranty Coverage on all equipment more than 100lbs. BakeMax assumes no responsibility for down time or loss of product. Repairs must be Pre-Authorized by BakeMax and have a Service Authorization Number issued prior to commencing Warranty Service.

Warranty begins 10-Days after shipping from warehouse; delays in installation which would extend the Warranty must be Approved. All equipment must be installed and connected by Qualified Professionals in accordance with the Manual Specification. Products shipped are to be inspected at time of delivery, the receiver is responsible for inspection.

Any abuse or improper use of the equipment will void the warranty. This includes failure to follow all cleaning instructions, improper installation, improper maintenance, failure to follow capacity charts, improperly wired electrical connections. The Warranty does not apply to abuse, willful or accidental damage, or to products used for other than their intended purpose. Normal wear parts such as Accessories, Attachments, or Electrical Components such as Fuses, Bulbs, Elements, and Switches carry a 90-Day Warranty only.

Bench Warranty (Machines Weighing 100 lb. or less)

Once the machine is Approved for Warranty Service, if the machine requires Warranty work in less than 30 days of purchase date, BakeMax will pay all shipping charges. Once the machine is received and repaired it will be returned to the user at BakeMax expense. Freight Damages during return shipping is the responsibility of the owner of the machine.

The following is not covered under the BakeMax Warranty:

1. Overtime Labor Rates are not covered by BakeMax.
2. All parts will be shipped via Ground Courier only; If Express Shipping is required, it will be the responsibility of the Customer or Dealer.
3. Travel for Warranty Service is covered up to 100 Miles /160 Km Roundtrip, any further milage will be the responsibility of the Customer or Dealer.
4. There is no on-site Warranty Service for Residential Addresses or addresses outside of the contiguous United States (*Lower 48*) or Canada.

***BakeMax machines sold outside of the contiguous United States (*Lower 48*), or Canada will carry 1-Year Parts Warranty only.*

Questions? OEM Parts?

Toll Free: 1-800-565-2253

Email: Info@BakeMax.com

www.BakeMax.com

BakeMax[®]

www.BakeMax.com