

BakeMax America BASPS Series Gas Stock Pot

The BakeMax America BASPS Series Gas Stock Pot is designed to provide the ultimate in performance and durability. As with all our heavy-duty countertop equipment, they are built to the highest commercial standards to ensure years of trouble-free service, featuring superior frame construction and stainless-steel exterior for easy maintenance. Combine all of this and our affordable prices and you have the best value for your budget.



Model BASPS001

Features:

- Available in (1) 3 Ring Burner and (2) 3 Ring Burners
- 90,000 BTU Output per Burner
- Constructed of Stainless-Steel for Durability & Ease of Cleaning
- 18" x 21" Heavy-Duty Cast Iron Top Grates designed for easy movement of pots across top sections.
- Deflectors to direct waste and crumbs to drip pan
- Landing ledge, promoting safety and functionality
- Independent manual controls for each burner
- 6" highly polished chrome adjustable steel legs.
- Full width catch tray funneling into a removable pan for easy cleaning
- 3/4" Rear Gas Connect
- LP Conversion Kit Included
- Gas Appliance Regulator Included
- 2-Year Limited Warranty



3 Ring Burner





Model BASPS002

** Due to continuous product improvement, specifications are subject to change without notice.

BakeMax[®] / Titan Ventures International Inc.

Warehouses:

20 Caribou St, Moncton, NB E1H 0P3 
5705 Valley Belt Rd Independence, OH 44131 
1201 E 27th Terrace Pittsburg, KS 66762 

Toll Free: 1-800-565-BAKE (2253)
Phone: 506-858-8990
Fax: 506- 859-6929
Email: Sales@BakeMax.com

BakeMax America BASPS Series Gas Stock Pot

Technical Specifications & Drawings

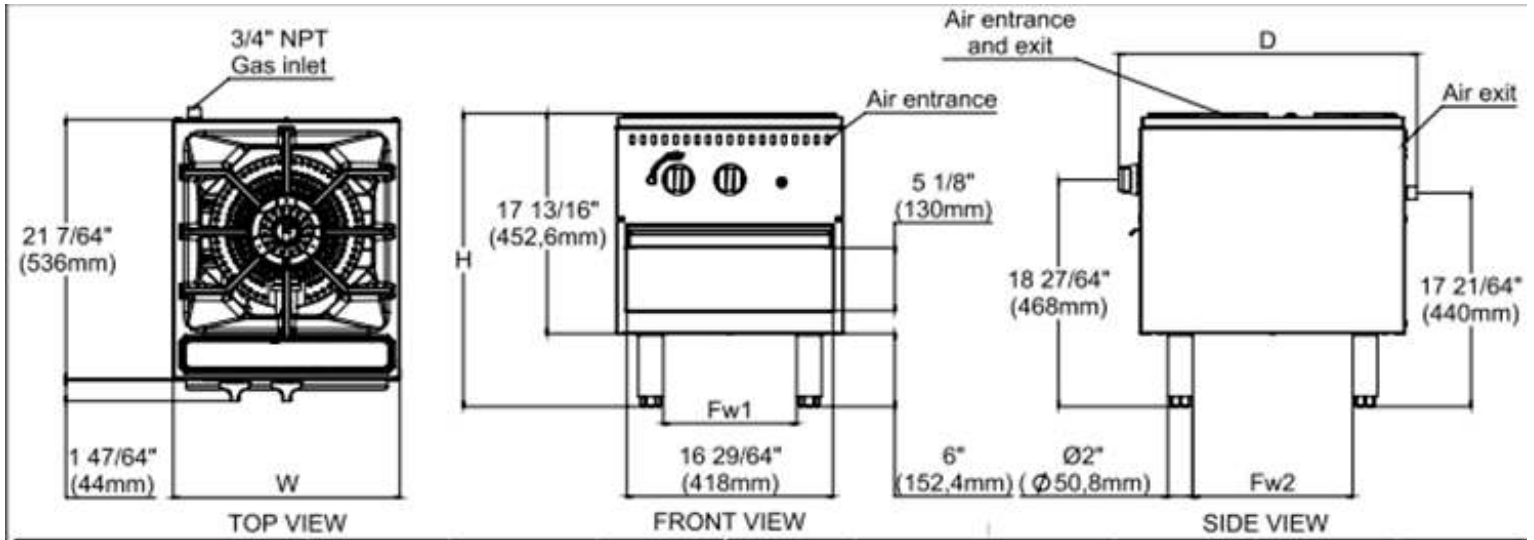

Model	Width (B)	Depth (C)	Height (A)	Burners	BTU NG	BTU LP
BASPS001	18"	24"	24"	1	90,000	90,000
BASPS002	18"	45"	24"	2	180,000	180,000



Shipping Information

Model	Net Weight Lbs./kg	Crated Weight Lbs./kg	Crated Dimensions (D x W x H)
BASPS001	104lbs / 47kg	121lbs / 55kg	29" x 23" x 25"
BASPS002	196lbs / 89kg	222lbs / 101kg	47" x 23" x 25"

***Warning:** The minimum supply pressure on this appliance must be set at 5 water column inches for natural gas and 10 water columns for propane gas. Each unit has a 3/4" gas connect at the rear of the appliance.

BakeMax[®] / Titan Ventures International Inc.

Warehouses:

20 Caribou St, Moncton, NB E1H 0P3 
 5705 Valley Belt Rd Independence, OH 44131 
 1201 E 27th Terrace Pittsburg, KS 66762 

Toll Free: 1-800-565-BAKE (2253)
Phone: 506-858-8990
Fax: 506- 859-6929
Email: Sales@BakeMax.com