



www.BakeMax.com

Model's BMSRAF & BMDRAF Operator's Manual

For Models with Integral Systems for Limiting the Emissions of
Grease Laden Vapors to Comply with EPA 202 / UL710B





WARNING: PLEASE READ AND FOLLOW THE INSTRUCTIONS BELOW BEFORE OPERATING PRODUCT

- When using the machine, please confirm that you have read all the instructions within this manual.
- Beware of any child/children or any other persons who are near the machine before operating.
- Do not put hand near moving parts.
- Remove all obstacles, which may interfere with machine functions.
- Keep work area clean and clear of clutter.
- Do not sit or stand on machine
- Do not wear loose cloth or jewellery when operating machine as it may get caught in moving parts and cause injury
- When the machine is abnormal or broken, you should stop using and check it or have it checked by a professional.
- Disconnect from power source before performing maintenance on the machine.
- When machine is not in use, please clean and store properly.
- Do not place any electrical parts or plug/cord in water.
- The cord should be away from the heat.
- Don't hang out the cord on the desk or cabinet.
- Machine may have sharp or pointed edges, use caution when cleaning.
- This machine should only be operated by personnel who can read, understand and respect warnings and instructions regarding this machine and the manual.
- Keep this manual in a safe place for further and regular reference and ordering parts.
- Please write model serial and date of purchase of your machine in the space provided in case you will need to order parts in the future.
- Always work by security code of your country, state, province, city or committee of your work place.

Table of Contents

| | |
|--|----|
| INTRODUCTION/PACKING LIST | 4 |
| INSTALLATION PREPARATION..... | 5 |
| INSTALLATION PROCEDURES..... | 6 |
| INITIAL OPERATION | 7 |
| INITIAL PROGRAMMING..... | 8 |
| MENU SETUP | 9 |
| COOK MODE..... | 10 |
| SYSTEM SETUP | 13 |
| MANAGER PROGRAMMING | 13 |
| SERVICE PROGRAMMING | 15 |
| COOKING PROCEDURES | 17 |
| PROCEDURES TO CLEAN AND MAINTAIN THE FILTERS | 21 |
| CLEANING PROCEDURES | 23 |
| PRODUCT REGISTRATION / SERVICE..... | 28 |
| WARRANTY | 28 |
| SERVICE..... | 28 |
| EXTENDED WARRANTY..... | 28 |
| RAF WIRING DIAGRAM..... | 29 |

INTRODUCTION/PACKING LIST

INTRODUCTION

Marketed since 2020, the Rapid Air Fryer® Rapid Air Fryer (RAF) is the result of years of research, development, and refinement. By using the principles of forced hot air and radiant heat, combined with an externally discharged catalytic converter and an air filtration system, the Rapid Air Fryer can quickly cook and brown several "oven ready" convenience foods. All without the need of a vented hood system! This easy-to-use countertop greaseless fryer safely and efficiently eliminates the health concerns, expense, and operating difficulties inherent with hot oil cooking processes.

PACKING LIST

Included in the Rapid Air Fryer packing carton are the following items:

- 1 Rapid Air Fryer Rapid Air Fryer which includes:
 - 1 Cooking Basket Assembly
 - 2 Cooking Basket Handles & Mounting Hardware
 - 5 3/8" screws (1 extra)
 - 6 nuts (2 extra)
 - 1 1/4" screw (extra)
 - 1 Drip Tray
 - 1 Three-Piece Air Plenum
 - 1 Removable Front Panel
 - 4 Adjustable Legs
 - 1 Operator's Manual
 - 1 Product Registration Form

INSTALLATION PREPARATION

Select a suitable position in the retail location to install the Rapid Air Fryer. Points to consider when selecting a location are:

1. Accessibility by store employees
2. Proximity to customers
3. Proximity to refrigerator and freezer equipment
4. Proximity to other retail points of sale to take advantage of cross merchandising opportunities
5. Sight line of customer (to enhance customer perception of "fresh" preparation).

The Rapid Air Fryer should be mounted on a sturdy, foodservice-appropriate surface. Stainless steel is the preferred material. Allow an adequate amount of workspace near the Rapid Air Fryer so that operators will not have to work in a confined location. A **minimum of 1"** of space between the rear, sides and top of the Rapid Air Fryer, and the walls, ceiling or other structural surfaces of your facility is recommended.

In addition to a suitable location, accommodation must be made for the necessary electrical connection. Please note the following electrical specifications.

Electrical Specifications

US / Canada / International: Single Phase, 50/60 Hz.

208 VAC USA (5760 Watts, 29 amps) 3-hour input averaging test, less than 24
amps, can be installed on 30 amp circuit

208 VAC – Canada - (4326 Watts, 21 amps)

230 VAC (5290 Watts, 23 amps)

240 VAC (5750 Watts, 24 amps)

RAF Receptacle (USA / Canada) NEMA #6-30R

INSTALLATION PROCEDURES

1. Open the shipping carton and lift off the top portion.
2. Lift off the 4 sides of the carton, leaving the Rapid Air Fryer and the corrugated cardboard packing set in place on the floor.
3. Remove the corrugated cardboard packing set from around the base of the Rapid Air Fryer.
4. Lift the fryer into position on the designated counter. The Rapid Air Fryer weighs approximately 165 lb. **The use of at least two people is advised for this step of the installation.**
5. A piece of tape is attached to each appliance leg to prevent them from shifting during shipment. Remove the tape from the appliance legs. Adjust the legs to level the fryer on the counter surface.
6. Pull out the Cooking Basket Assembly and remove the plastic bag containing the Cooking Basket handles, screws, nuts, wrench, Operator's Manual, and 34-page Menu.
7. Mount the Cooking Basket handles to the Cooking Basket by attaching two 3/8" screws with acorn nuts to the base of each handle using the wrench to tighten. We recommend tightening the acorn nuts a good half turn past the point of resistance to lock them tightly into place.
8. Take the four adhesive backed rubber leg stops and mount them to the bottom of the four adjustable legs. This is to prevent the Rapid Air Fryer from sliding on a stainless-steel appliance stand or table.

INITIAL OPERATION

Plug the RAF into the NEMA# 6-30R electrical receptacle. Plugging in the RAF to the receptacle is only done on the initial operation of the unit, and the RAF does not need to be unplugged when it is powered off at the end of the day.

The initial image that will appear on the screen will display the time of day at the top of the screen and “Power” button in the center of the screen. (if the time of day is incorrect, we will show you how to update the time later in this manual).

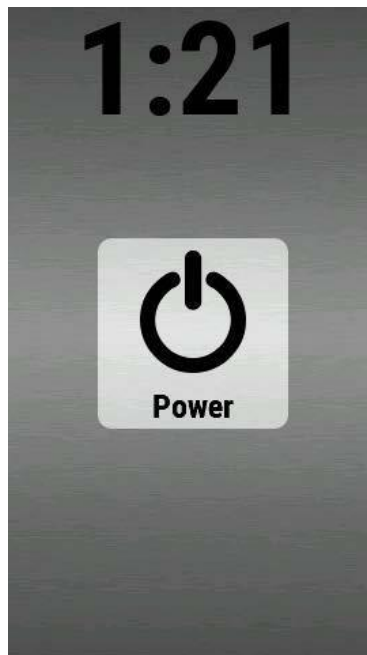

INITIAL PROGRAMMING

Touch the “Power Button” and this will take you to main operation screen display.



From this screen, you can touch the “Menu Setup” to create and modify up to 108 cooking recipes. You can touch the “Cook” icon to engage any of these recipes.

You can touch the “System Setup” to access either the “Manager” or the

“Service” programming features of the RAF. You can touch the “Help” icon to access the contact information for QNC, Inc. as well as to view the most recent firmware that has been uploaded into the RAF Controller.

MENU SETUP

The RAF Menu Setup utilizes six “Groups” and this screen will display the factory pre-set Groups of Grill, Bake, Fry, Breakfast, Lunch, and Dinner. The names of these Groups can be edited to names of your choosing by touching the Group icon and then selecting the “Edit” key. If the Group has an image uploaded to it and you wish to change the image, you will need to delete the Group and then add a new Group.

Each of the six Groups can accommodate 18 individual recipes. Push one of the “Groups” on the screen and then touch edit. It will display the recipes that have been created for this Group. For our example push “FRY” and then click “Edit” at the bottom right hand side of the screen. This will display up to 18 recipes that have recipe name, time, temperature, and blower speed.

To edit any of the recipes that have been preloaded into the controller, click on the recipe. To modify any of the fields within a recipe, just click on the field and it will take you to a keyboard for you to update the text or numbers within the field. Hit OK to save your changes. Some recipes with cooking times and temperatures have been entered at the factory for guidelines. Again, click on the fields to change the time and temperature. For the “Blower” field, we recommend that you utilize the “High” setting for most recipes. There is also a larger field in each recipe, located below the name of the recipe. In this field, you can upload a bitmap image of the product that you wish to use for this recipe.

For the field with the images, you can click on the field and enter any of the images in the factory library. You can also add your own images that are in a Bitmap (BMP) format. The maximum image pixel width is 180 and maximum height is 120 and they can be a 24 or 32 Bitmap. We found a free converter program at <https://onlineconvertfree.com/convert-format/jpg-to-bmp/>. This program will convert your images from JPEG to BMP and will then allow you to resize the BMP file. There are other programs that you can use to convert images into a BMP file such as Photoshop and others.

COOK MODE

When you touch the “Cook” icon, it will engage the last recipe that had been run in the RAF. If you wish to utilize a different recipe within the same “Group”, touch the recipe that is displayed, it will now display the recipes that are programmed within that Group. If you wish change Groups, touch the Group icon at the lower left part of the screen, and then click on the Group you wish to use. This will take you to the programmed recipes within that group. From there, you can select the recipe that you wish to run next.

The top left of the screen will display current oven temperature, the top center will display the programmed cooking temperature, and the top right will display “Heating”. The section below will display the field with the name of the recipe, the programmed cooking time, and the programmed Blower speed.



When the RAF oven temperature has risen to within 5° F of the programmed temperature, the top right image of the screen will display “Ready” and the center right portion of the screen will display “Start” with a right pointing arrow. When the “Start Arrow” button is illuminated, you can now pull the basket out of the cooking chamber, place your menu items into the basket (display will show “Paused Door Open”. Push the basket back into the RAF and hit the Start button.



The two-speed cooking blower will change from low speed to high speed. When the countdown timer reaches 0:00, the buzzer will engage, and the operator will need to hit the “Stop” button to stop the buzzer. The RAF will stay at this recipe and maintain the cooking temperature for this recipe until the operator changes either the recipe or the Group or goes to the “Home” screen.

If you wish to engage a different recipe after the previous one has finished, and it’s in the same Group, touch the recipe name and it will take you

to all of the recipes within that Group. Touch the recipe that you wish to use next and if the RAF needs to continue to preheat, it will continue to heat up until the

temperature is within 5 degrees of the preprogrammed temperature. You can now touch “Start” to engage this recipe.

If you wish to engage a recipe that is located in a different Group, you need to touch the “Group” button at the bottom left of the screen, and then select the Group that you wish to use next, and then the recipe within that Group.

If the Home screen is engaged, the Main Screen is then displayed, and it will continue to maintain the temperature setting from the most recent recipe that was utilized. If the Operator is done for the day, hit the “Power Down” button. This will turn off the RAF heaters. The cooling blowers will continue to operate in the low speed blower mode for up to 15 minutes to assist in the cooldown of the RAF.

SYSTEM SETUP

The System Setup icon will take you to the screen below with two options. You can sign in as the Manager or as the Service Technician.

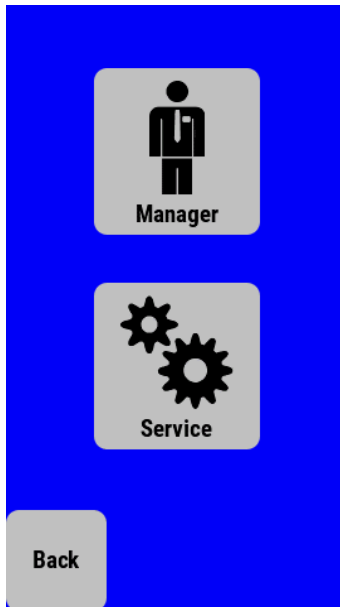

MANAGER PROGRAMMING

Click on the Manager icon and enter the code, 0001 and click "OK". The following screen will appear:

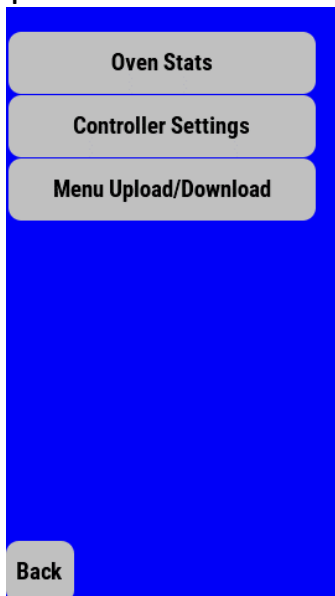

The first field is **Oven Stats**. If you click on this screen, it will show you information on the operation of the RAF including the number of Bakes Completed, Bakes Started, Fan Powered on, as well as additional historical information.

The second field is **Controller Settings**. If you click on this field, you can adjust the following:

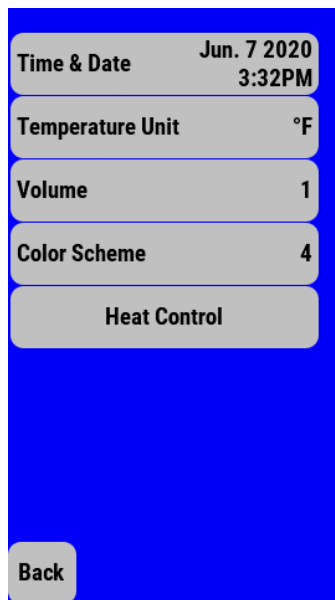

The **Time & Date** field is used to edit the time and date that appears on the main screen.

The **Temperature Unit** field allows you to change the temperature display from Fahrenheit to Celsius. Just touch the screen and it will move you from one setting to the other.

The **Volume** screen allows you increase the level from one to ten. Each time you touch the display, it increases the volume up the next level. To get back to a lower level, you need to move up to level 10 and then the next touch will take you back to level zero.

The **Color Scheme** provides you with five preset display colors. The factor preset is #4 which is a blue background.

The **Heat Control** is a screen that we recommend that YOU DON'T ADJUST. The factory preset for this section is PID enable. This feature adjusts the temperature rise and drop within a recipe to maintain a consistent cooking temperature. If you change this screen to "No" the RAF will most likely overshoot the preset cooking temperatures for each recipe.

The third field is **Menu Upload/download**. This feature allows up to download a file with the programmed Groups and Recipes on the RAF to a USB Thumb Drive. This file can then be used to upload these recipes to other RAF units.

Menu Export:

Insert Thumb drive into USB port at the control box on the right side of the unit by the power cord. Once the USB Thumb drive is inserted press the Export button on the screen.

Menu Import:

Repeat same procedure as used for import function

SERVICE PROGRAMMING

Enter Passcode 0002 which will provide access to a subset of features found under "Service". The first three options were already addressed in the "Manager"

screen.

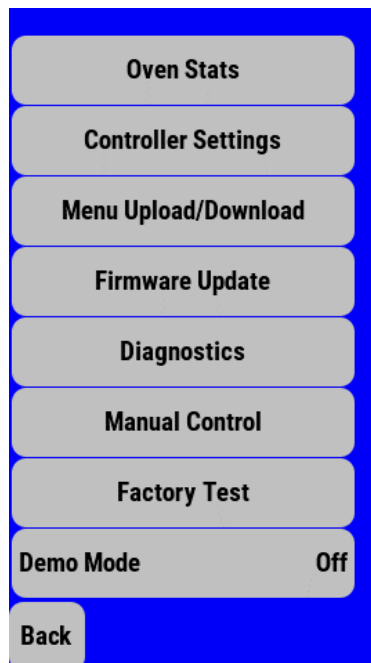

Controller Settings:

There are additional settings in this screen that are not shown from the “Manager” access. We recommend that you do not change any of these additional settings.

Firmware update:

QNC will periodically update the software on the RAF and this screen provides you with the option of updating your Firmware. QNC will email updated firmware from time to time, and this file needs to be entered onto a USB Thumb Drive which can then be uploaded into the controller. Alternatively, if only one UI firmware file is on a flash drive and that flash drive is in place when power is applied to the control, the control will automatically update.

Diagnostics:

View, Erase, and Export the fault log.

Manual Control:

Allows the user to bake with a set bake time/temperature and blower speed without creating a recipe. A start button is visible if the cavity temperature is within 5° F of setpoint.

Factory Test:

This screen shows the input status and allows the user to exercise all outputs. The control reverts to a “Safe State” (Heaters Off) when exiting this screen.

Demo Mode:

This screen is reserved for future applications

COOKING PROCEDURES

The Rapid Air Fryer RAF can fry, grill, and bake a wide array of frozen, **oven-ready** products available through normal food service distribution and wholesale clubs.

To prepare "fried" menu items in the RAF, the foods selected must have oven preparation directions listed on the package. As an example, egg rolls, corn dogs, beer battered or tempura battered vegetables and battered cheese sticks are typically fryable or bakeable. Seasoned or coated French fries or potato wedges are fryable or bakeable. These types of products will come out of the RAF crisp on the outside and moist on the inside as if they were fried. To prepare a non-battered, non-coated, or non-seasoned menu item, it must be a bakeable version. To prepare shoestring or crinkle cut French fries, or skin-on potato wedges, you must use a bakeable version.

Menu items prepared in the RAF that do not have baking directions listed on the package will typically be soggy and limp, and will not change in color from a pale white to a golden brown. Contact your food distributor to order the correct version of the menu item to prepare. If the food distributor salesperson is not sure of the menu items that can be prepared in the Rapid Air Fryer, have them review the 32 page menu found in this Operators Manual, or have them contact the Rapid Air Fryer distributor, or QNC, Inc. directly.

To prepare breaded items such as chicken nuggets and chicken strips either a pre-cooked or a fully cooked product must be used. Pre-cooked means that the product has been partially cooked, is pre-browned on the outside, and the interior of the product is raw. Fully cooked means that the product is cooked on both the outside and the interior. You cannot prepare ready-to-cook items that have a white breading on the outside. They will cook, but they will not turn golden brown in the Rapid Air Fryer.

To grill foods in the Rapid Air Fryer, you should use pre-cooked or fully cooked meat, poultry, or fish products. As an example, hot dogs and some sausages are fully cooked products and could be consumed cold right from the package. These items will grill in the Rapid Air Fryer with a charbroiled appearance. To prepare grilled chicken breasts or hamburgers, use fully cooked products. These products

will come out of the Rapid Air Fryer sizzling on the outside and tender and juicy on the inside.

The Rapid Air Fryer can bake frozen pizzas or prepare freshly made pizzas using a par-baked crust. Please note that an optional pizza basket is available. Please contact QNC for pricing information Prepare hot, open-faced sandwiches in just 60 to 90 seconds. To bake cookies, pastries, or muffins, lower the temperature setting to 350°F and use a muffin tin, a small sheet pan, or parchment paper.



Optional Pizza Basket



Cheese Pizza

Please note the following general cooking procedures:

1. Always spray the Cooking Basket and Drip Tray with an aerosol vegetable shortening (for example, Pam® for Grilling) prior to the first cooking cycle of the day, or the first cooking cycle since cleaning. **Do not spray non-stick aerosol directly into the fryer, or while the fryer is operating.** Wipe any excess oil from the Drip Tray with an absorbent paper towel or bar towel. **To help reduce any drag between the Drip Tray and Tray Guides, pull the Drip Tray out as far as possible, and rub the towel with the excess oil on the underside of each side of the Drip Tray.**

2. For best results, prior to the first cooking cycle of the day, warm the Rapid Air Fryer at the preprogrammed cooking temperature for 10-15 minutes.
3. Most menu items will cook in the Rapid Air Fryer RAF between 410°F and 475°F. **Cooking at a temperature higher than 500°F can cause the Rapid Air Fryer to smoke.** If smoke is emitted from the Rapid Air Fryer, either clean the Cooking Basket and Drip Tray and/or lower the temperature setting.
4. Similar products will vary in cooking time depending on internal temperature at the time of cooking. For example, frozen fried chicken will take longer to cook than the same fried chicken that has been thawed in the refrigerator.
5. Arrange the product to be cooked in a single layer in the Cooking Basket. Avoid stacking the product to be cooked. A single layer of product will cook more evenly than products placed into the Cooking Basket in a stacked or clumped arrangement.



French Fries Layered on Cooking Basket

6. Select a Menu time approximately 65% of the food manufacturer's suggested convection oven cooking times. As an example, if the suggested convection oven cooking time is 10 minutes, this item should take approximately 6.5 minutes in the Rapid Air Fryer.

7. Please be aware that the cooking times can vary depending on variances in voltage at the facility, and the quantity of food being cooked at one time. Experimenting with cooking times and temperatures and recording the results for future reference is recommended. This testing will prevent under-cooking or burning of food products.

8. Remove cooked product from the open Cooking Basket with a spatula or tongs. For small food products, such as French fries, remove the Cooking Basket entirely with both hands on the handles, and dump the food product into a foil pan or holding container. *CAUTION: DO NOT INSERT TONGS OR SPATULA INTO THE COOKING CAVITY.* This is extremely dangerous and could result in injury to the operator.

PROCEDURES TO CLEAN AND MAINTAIN THE FILTERS

Please note that the filters must be cleaned (weekly) and changed on a regular basis (every 3 months) or the unit will not operate properly. Sufficient air flow must pass through the filters to insure that the RAF operates properly.

1. The **Air Filtration Bracket** holds 2 separate air filters. The Bracket can be removed by grabbing it on each side and lifting the front air filtration cone, turning the cone upside down and sliding the locking latch away and removing the Filters and sliding it out.

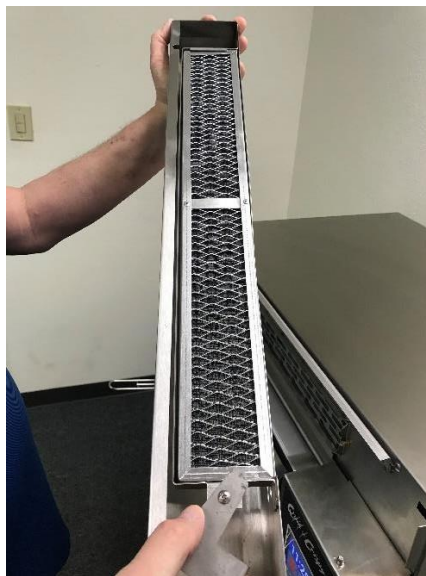

2. The 2 filters have different thicknesses, and are cleaned in the following manner:

Filter Tray Assembly

- a. The **Grease Filter** is the thinner of the two with the wire mesh screen. It is in the front of the Filter Tray it can be cleaned either in a sink or dishwasher.
- b. The **Electrostatic Filter** is the thicker of the two and is in the rear of the Filter Tray. It **cannot be immersed in water**. We recommend periodically wiping the sides with a degreaser.

CLEANING PROCEDURES

NOTE: PRIOR TO ANY CLEANING OR MAINTENANCE, THE POWER MUST BE IN THE "OFF" POSITION. THIS SAFETY PRECAUTION WILL PREVENT ACCIDENTAL EXPOSURE TO HIGH VOLTAGE.

There are two types of cleaning procedures recommended for the Rapid Air Fryer.

To prevent product buildup on the Cooking Basket during the day, as well as transfer of flavors from one product to the next use the following procedure:

1. After preparing menu items in the Rapid Air Fryer, a layer or coating of sauce, crumbs, or batter may be deposited on the Cooking Basket or Drip Tray. These deposits should be removed before cooking another batch of food. Pull out the Cooking Basket, and with it still over the Drip Tray; **brush the inside of the basket with a brass bristle brush**. Turn the basket over and repeat brushing. This should remove all large food particles from the Cooking Basket.



Brushing the Cooking Basket

2. With the Cooking Basket removed from the Rapid Air Fryer and the Drip Tray extended out, **scrape the Drip Tray with a stainless steel dough cutter or bench scraper**. Simply scrape the Drip Tray from the back to the front. Three strokes of the scraper from the rear to the front and one scrape from

one side to the other should place all of the crumbs and excess oil to one of the front corners of the Drip Tray.



Scraping the Drip Tray to Clean

Remove this residue with the scraper and discard. Wipe the Drip Tray with a dry paper towel or cloth and re-insert.



Discard Crumbs and Residue

Both the brass bristle brush and bench scraper are available from QNC, Inc.

For complete cleaning at the end of the day, repeat the above procedure and then:

3. Remove the **Cooking Basket Assembly** from the Rapid Air Fryer.
4. Remove the **Drip Tray** by pushing it fully into the unit, lifting the rear of the tray upwards and sliding it forward.
5. Use oven mitts to lift the **Removable Front Panel** located directly above the Cooking Basket by applying slight upward pressure.
6. Pull the **Air Plenum** out of the cooking chamber.



Air Plenum Pulled Out of the RAF

7. Slide out the **Rear Splashguard** from the back of the cooking chamber.
8. Disassemble the Air Plenum into three separate pieces, the top and the two sides. Place the plenum on a countertop and lift the top center of the plenum upwards approximately 1/2". Fold the two sides of the plenum inwards and remove them from the top plenum piece.
9. Please note the flanges on the front of the sides of the air plenum are taller than the flanges on the rear. It is important when reassembling the Air Plenum that they be placed together properly.

10. There are two alternatives for cleaning the Cooking Basket, Drip Tray, Splashguard, the two-piece Removable Front Panel, and the Air Plenum.

- a. **Place the pieces into either a sink containing a pre-soak solution with a commercial degreaser, or a commercial dishwasher.** We suggest that the use of a wire brush for cleaning the Cooking Basket and green scrubbing pad for other stainless-steel items. The items should then be cleaned according to local health department guidelines. This usually requires steps of washing, rinsing, sanitizing, and air-drying.

OR

- b. **Soak the pieces overnight in a solution of Dip Tank Cleaner (DTC-2), and water.** DTC-2 is a caustic chemical available from either your Rapid Air Fryer distributor or QNC, Inc. Please call 1-888-668-3687 for more information.

Two 2 lb. Jars of DTC-2 should be added to 30 gallons of water in a 50-gallon storage container. This solution may be reused for 30 to 45 days depending on the quantity and types of foods prepared in the Rapid Air Fryer.

- c. **CAUTION: ALWAYS WEAR RUBBER GLOVES AND EYE PROTECTION WHEN HANDLING CAUSTIC CHEMICALS.**
- d. **DO NOT PLACE THE FILTERS INTO THIS SOLUTION. THEY ARE MADE OF ALUMINUM AND WILL DISSOLVE IF PLACED INTO THE SOLUTION.**
- e. A minimum of 4 hours of soaking is recommended to remove baked-on, carbonized grease that may be on these parts. Prior to re-inserting these parts into your Rapid Air Fryer, wash, rinse and sanitize them. Allow them to air dry and then place them back into the Rapid Air Fryer.

Depending on the amount of carbonized food accumulation on the inside of the Rapid Air Fryer, it may be necessary to clean the inside of the cooking chamber with a commercial oven cleaner possibly as often as each day or as infrequently as once a week. The frequency depends on the quantity of foods you prepare and the oil content of these various foods. Always use these products in accordance with manufacturer's directions.

QNC, or your Rapid Air Fryer distributor, has available a cleaner called Dip-R-Spray that is excellent for use in your Rapid Air Fryer. It is safe to use and is the most effective cooking chamber cleaner that we have evaluated to date. It is applied to the cooking chamber after it has been pre-warmed to 200° F. Upon contact with the spray, the carbonized grease is dissolved. The cooking chamber is then sprayed lightly with a vinegar and water solution (at least one-third vinegar) to neutralize the Dip-R-Spray and wiped with a clean cloth. The interior of the unit will be left clean and streak free.

PRODUCT REGISTRATION / SERVICE

PRODUCT REGISTRATION

After having thoroughly reviewed the Operator's Manual, complete the enclosed Product Registration accurately and return it to QNC, Inc. If the Product Registration was misplaced or one was not included with your Rapid Air Fryer, contact your distributor or call QNC, Inc. at 888-NO-VENTS (668-3687) or 972-669-8993, Fax at 972-669-8990, or complete it online at our website, www.q-n-c.com.

WARRANTY

The Rapid Air Fryer has a limited warranty of 1 year on all parts, and 90 days on labor from the date of installation of the unit. See the Product Registration for more specific information.

SERVICE

To request service of the Rapid Air Fryer contact the installing distributor or QNC, Inc. at 888-NO-VENTS (668-3687) or 972-669-8993. If a service call is required it will be scheduled promptly.

EXTENDED WARRANTY

A 3-year extended warranty is available for purchase for up to one year following the purchase of a Rapid Air Fryer Greaseless Fryer. For more information contact your distributor or call QNC, Inc. at 888-NO-VENTS (668-3687) or 972-669-8993.

RAF WIRING DIAGRAM

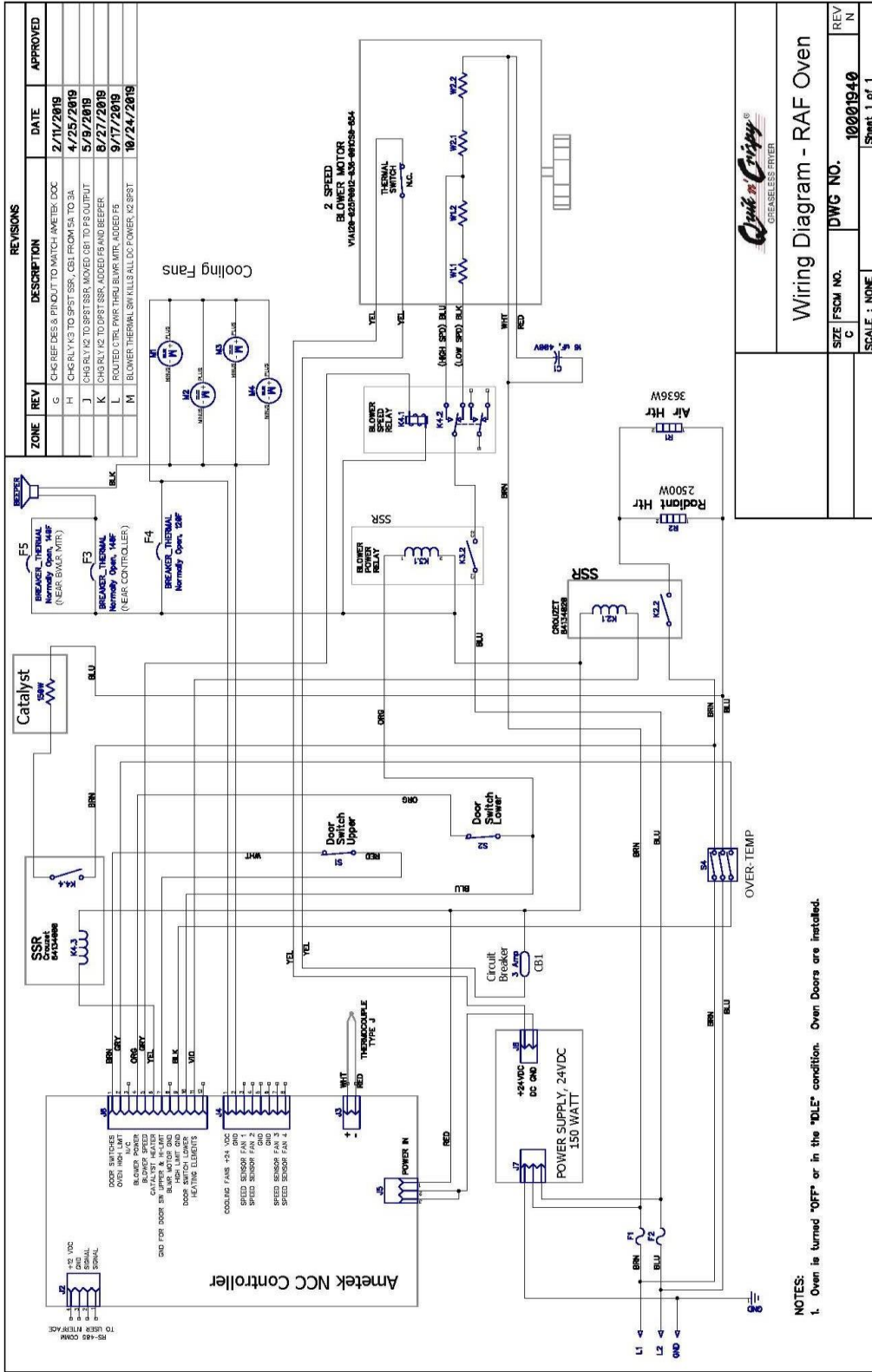

Wiring Diagram - RAF Oven

| | | | |
|--------------|----------|----------|--------------|
| SIZE | FSCM NO. | DWG NO. | REV |
| C | | 10001940 | N |
| SCALE : NONE | | | Sheet 1 of 1 |