



# Operations Manual Euro Smart Sheeter BMTPS16



**Questions? Contact Us:**  
**Toll Free: 1-800-565-2253**  
**Email: [Info@BakeMax.com](mailto:Info@BakeMax.com)**  
**[www.BakeMax.com](http://www.BakeMax.com)**



## WARNING: PLEASE READ AND FOLLOW THE INSTRUCTIONS BELOW BEFORE OPERATING PRODUCT





- When using the machine, please confirm that you have read all the instructions within this manual.
- Beware of any child/children or any other persons who are near the machine before operating.
- Do not put hand near moving parts.
- Remove all obstacles, which may interfere with machine functions.
- Keep work area clean and clear of clutter.
- Do not sit or stand on machine
- Do not wear loose cloth or jewellery when operating machine as it may get caught in moving parts and cause injury
- When the machine is abnormal or broken, you should stop using and check it or have it checked by a professional.
- Disconnect from power source before performing maintenance on the machine.
- When machine is not in use, please clean and store properly.
- Do not place any electrical parts or plug/cord in water.
- The cord should be away from the heat.
- Don't hang out the cord on the desk or cabinet.
- Machine may have sharp or pointed edges, use caution when cleaning.
- This machine should only be operated by personnel who can read, understand and respect warnings and instructions regarding this machine and the manual.
- Keep this manual in a safe place for further and regular reference and ordering parts.
- Please write model serial and date of purchase of your machine in the space provided in case you will need to order parts in the future.
- Always work by security code of your country, state, province, city or committee of your work place.

# ***MANUAL for USE and MAINTENANCE***

## ***Pizza Sheeter***

### **WARNINGS**

THE SYMBOL  REGARDS WARNINGS FOR THE SAFETY OF THE OPERATORS, USERS AND MAINTENANCE WORKERS OF THE PRODUCT.

-  CONSERVE THIS MANUAL FOR FURTHER CONSULTATION
  -  THE INSTALLATION MUST BE CARRIED OUT BY SPECIALIST AND AUTHORIZED PERSONNEL AND ACCORDING TO THE INSTRUCTIONS OF THE MANUFACTURER
  -  FOR ANY EVENTUAL REPAIRS, CONTACT EXCLUSIVELY A SERVICE CENTRE AUTHORIZED BY THE MANUFACTURER AND ASK FOR THE USE OF ORIGINAL SPARE PARTS
  -  REFUSAL TO RESPECT THE ABOVE CONDITION JEOPARDIZES THE SAFETY OF THE OPERATOR
  -  CONTACT YOUR RELIABLE RETAILER FOR THE ADDRESS OF YOUR NEAREST AUTHORIZED QUALIFIED TECHNICIAN
- THE MANUFACTURER RESERVES THE RIGHT TO MODIFY AT ANY MOMENT AND WITHOUT ANY NOTICE THE CONTENTS OF THIS MANUAL

## **PRELIMINARY**

*With the help of this manual, the Manufacturer provides all the technical elements necessary for a correct installation and working of the appliances. The user is responsible for following these instructions. The aspects concerning the protection of safety and the environment are also pointed out together with the characteristics, workings, installation and maintenance of the machine.*

*It is important to read this manual carefully before using the product, and whenever the need arises to consult it. Adhere to the technical instructions provided and follow all the indications scrupulously. For the safety of the operator, the devices of the machine should always be kept in good working order.*

*This manual, an integral part of the machine, must be kept in an accessible place known to all operators, and made available to the authorized personnel for any eventual maintenance and repairs.*

## **GUARANTEE**

*All equipment parts, except for the electric devices, are covered by a one-year guarantee, provided that faults are due to manufacturing. The delivery of the above mentioned parts is to be paid by the receiver. An invoice will be issued for any replacement of parts covered by the manufacturer's guarantee; on receiving the equipment parts for which replacement was required (carriage-free goods), customers will be given a credit note. Replacement of the entire equipment is not covered by guarantee, nor are manufacturing costs necessary to replace parts or any other additional expenses.*

## **SHIPMENT**

*Goods are shipped at Buyer's risk. Any complaint about the faulty condition of cargo must be made to the carrier immediately after delivery. Please check that goods were not damaged during shipment and if so inform the carrier immediately after delivery. We are not liable for damage which was not reported to the carrier shortly after receiving the shipment, even if it was forwarded free of charge and with invoice.*

00 INDEX

- 0 Index
- 1 Description
  - 1 Description of the Machine
  - 2 Environmental Notes
  - 3 Technical Characteristics
  - 4 Safety Principles
- 02 Installation
  - 1 Packaging Contents
  - 2 Connections
- 03 Workings
  - 1 Safety Characteristics Present
  - 2 Controls
  - 3 Starting the Machine
  - 4 Turning off the Machine
  - 5 Use
  - 6 Irregularities of the Machine
- 04 Maintenance
  - 1 Cleaning
  - 2 Regular Maintenance
  - 3 Special maintenance
- 05 Diagrams
  - 1 Electrical Diagram
  - 2 Spare Parts
  - 3 Ordering of Spare Parts
  - 4 Chart of Risks

## **01 DESCRIPTION**

### **01.01 Description of the Machine**

The Pizza Roller, with two pairs of parallel rollers, has been designed to roll out only room temperature dough for the preparation of pizzas, bread, pasta for first courses, flat loaves and cakes and others, of various forms obtaining the thickness and diameters required.

The machine, designed in accordance with the European regulations, has been manufactured to protect the user from the risks connected to its use; for this reason, the machine is equipped with special protections to avoid the risks of crushing and entanglement, due to contact with the moving parts.

The machine has been produced with specific materials designed for contact with food products (the parts in contact are in stainless steel) and it is run by a monophase motor.

### **01.02 Environmental Notes**

<b>NOISE</b>	The Machine presents a Lep.d value of less than 70 dB(A) If positioned in areas with a noise value of more than 80 dB(A), the employer must form and inform the operator of the risks from exposure to the noise and must take the necessary precautions according to the authorized doctor.
<b>PACKAGING</b> type of ma-	Do not throw away the packaging, separate it according to the material (eg. cardboard, wood, plastic material, etc.) and dispose of them in conformity with the local and national laws in force.
<b>DISPOSAL</b> the residue	Operate in accordance with the local and national laws in force: of cleaning are assimilated in urban areas.
<b>OUT OF ORDER</b>	At the end of the Machine's working life: <ul style="list-style-type: none"><li>• Deactivate the Machine, by disconnecting it from the electric power supply and cutting the supply line cable.</li><li>• Disassemble the Electronic Panel.</li><li>• Disassemble the components, separating the various types and send them to the scrapyard or dispose of them according to the local and national laws in force.</li></ul>

### **01.03 Technical Characteristics**

Refers to ALL. 1.

THE SERIES, THE VERSIONE, THE TENSION AND THE FREQUENCY FOR USE OF THIS APPLIANCE ARE WRITTEN ON THE COVER OF THIS MANUAL FOR USE AND MAINTENANCE

THE TYPE AND THE REGISTRATION NUMBER, STAMPED ON THE PLATE, MUST ALWAYS BE QUOTED, EVERY TIME THAT THE MANUFACTURER OR LOCAL RETAILER IS CONSULTED FOR INFORMATION OR FOR ORDERING SPARE PARTS

**01.04**      **Safety**  
**Principles**



BEFORE TURNING ON THE MACHINE, AND EVERY TIME A DOUBT ABOUT ITS WORKINGS SHOULD ARISE, EVERY OPERATOR IS OBLIGED TO CAREFULLY READ THE INSTRUCTIONS FOR USE. ENSURE THAT THE PEOPLE CONCERNED KNOW AND ADHERE TO THE CONTENTS OF THE MANUAL.



DURING PHASES OF RESEARCH OR REMOVAL OF ANY CAUSE OF DAMAGE OR INCONVENIENCE CONCERNING THE MACHINE, TAKE ALL NECESSARY MEASURES TO PREVENT ANY DAMAGE TO PEOPLE OR THINGS. REMOVE THE ELECTRIC TENSION (SEPARATION OF THE MACHINE FROM THE ELECTRIC NETWORK) BEFORE APPROACHING THE PROTECTIVE DEVICES.



AT THE END OF ANY INTERVENTION THAT REQUIRES THE REMOVAL OR THE NEUTRALIZATION OF ANY COMPONENT CORRELATED TO SAFETY ( BARRIERS, SENSORS, PROTECTIONS, ETC.), CARRY OUT THE PUTTING BACK INTO OPERATION ENSURING THE CORRECT POSITION AND EFFECTIVENESS.



IT IS ABSOLUTELY FORBIDDEN TO NEUTRALIZE, REMOVE, MODIFY OR IN ANY OTHER WAY RENDER INEFFICIENT, ANY PART OF THE SAFETY DEVICES , PROTECTIVE DEVICES, OR CONTROLS OF THE MACHINE, WHEREVER POSITIONED. ALL THE PROTECTIVE AND SAFETY DEVICES MUST BE KEPT IN PERFECT CONDITION AND WORKING ORDER.

## 02 INSTALLATION

### 02.01 Packaging Contents

On delivery, this Manual for the Use and Maintenance containing the Declaration of Conformity of the product with the EC regulations, is attached to the machine and considered an integral part of it.

The machine arrives in a single package ready for use. Take care to handle the box only manually, always keeping it in an upward position as indicated on the box.



NEVER LIFT THE PACKAGE USING A

### 02.02 Connections

- Before positioning the Machine, ensure that the bearing surface is a horizontal level. If the electric Pedal control is present, insert its plug in the correct appropriate socket to be found at the side of the machine.
- Connect the machine to the electric power supply, then:
- Ensure that the tension and frequency of the power supply correspond to that written on the plate.
- Ensure that that socket is connected to earth.
- The Manufacturer specifies that the mains line should be equipped with safety devices by a differential switch, coordinated with the general earth installation, in conformity with the local and national laws.
- Check that the safety devices of the Machine are present and assembled before activating the machine.

Using the Machine for the first time:

- Clean carefully with a soft, clean cloth
- Repeatedly pass a piece of dough through the rollers.



CONNECT THE MACHINE ONLY TO PARTS OF THE ELECTRICAL PLANT WHICH ARE INDIVIDUALLY PROTECTED, I.E. WITH A DIFFERENTIAL SWITCH



CHECK THE ELECTRICAL STANDARDS OF THE COUNTRY IN WHICH THE



MACHINE IS INSTALLED DO NOT REMOVE THE SAFETY DEVICES WHEN THE

MACHINE IS IN USE.



03 WORKINGS

03.01 Safety Devices Present

The Machine is equipped with fixed suitable security devices, present on both the upper and lower pairs of rollers



DO NOT REMOVE THE SAFETY DEVICES WHEN THE MACHINE IS IN USE

THE MANUFACTURER DECLINES ALL RESPONSIBILITY IF THE INSTRUCTIONS ARE NOT FOLLOWED

03.02 Controls

CONTROL	ACTION	posr ON THE IV	HON ACHINE
MAIN SWITCH	START (ON) / SHUT DOWN (OFF) OF THE MACHINE -NO MOVEMENT IS GENERATED BY PUSHING THIS SWITCH	SIDE	SIDE
ON SWITCH	ACTIVATES (ON) THE ROTATION OF THE MACHINE'S ROLLERS	FRONT PANEL	FRONT
OFF SWITCH	DISACTIVATES(OFF) THE ROTATION OF THE MACHINE'S ROLLERS	FRONT PANEL	FRONT
ELECTRIC PEDAL SOCKET	IN THIS SOCKET, INSERT THE PLUG FOUND ON THE CONNECTING CABLE OF THE ELECTRIC PEDAL	SIDE	SIDE
ELECTRIC PEDAL	SIMULATES THE FUNCTIONS OF THE ON/OFF SWITCHES. ACTIVATES AND DEACTIVATES THE ROLLERS. CONNECTS TO THE ELECTRIC PEDAL SOCKET. ONCE CONNECTED, EXCLUDES THE FUNCTION OF THE ON/OFF SWITCHES.	GROUND LEVEL	GROUND LEVEL

### 03.03 Starting the Machine

— **STARTING THE MACHINE WHEN TURNED OFF**

1. Main Switch
2. ON Switch or press the Electric Pedal if present.

— **STARTING THE MACHINE WHEN LIVE**

To restart the machine, after a suspended period, it is necessary to follow only point 2 above.

 THE PARTS OF THE MACHINE IN MOVEMENT CONTINUE TO ROTATE AS LONG AS THE WORKING LASTS: THE SAFETY DEVICES PRESENT, ON EACH PAIR OF ROLLERS, PERMIT THE ROLLERS TO CONTINUE ROTATING WHILE WAITING FOR WORK TO RESTART.

### 03.04 Turning off the machine

— **SHUT DOWN**

Shut Down of the machine occurs every time that the OFF button is switched, or the Electric Pedal is released.

— **TURNING OFF THE MACHINE**

1. OFF Switch or press the Electric Pedal if present.
2. Main Switch



WHEN THE MACHINE IS NOT ACTIVATED, IT IS ADVISABLE TO TURN OFF THE MAIN ELECTRICAL POWER SUPPLY, OR DISCONNECT THE MACHINE FROM THE OUTLET.

03.05 Use

Form small round balls of dough possibly of the same weight to enable the easy formation of pizza bases and bread.

Position one of the small balls between the upper rollers and regulate the position with the special regulator, so that the rollers are almost half open.

Remember that before doing the above, the lower rollers must be positioned with the special regulator: for example, to obtain the final form required for the formation of pizza bases and bread, the rollers must be half closed.

The dough fed through the upper rollers takes on an oval form, and the special little scales in the centre of the chute, will automatically turn the dough by 90° and feed it into the set lower rollers.

The counterweights of the scales must be regulated, according to the weight of the dough balls.

If the scales are not used, either because removed by the user or not present, they must be substituted with hands: once the portions have been fed into the upper rollers, feed them into the lower rollers taking care to position the edges of the oval dough parallel to the rollers.

DO NOT REMOVE THE SAFETY DEVICES WHEN THE MACHINE IS IN USE.

THE MANUFACTURER DECLINES ALL RESPONSIBILITY IF THE INSTRUCTIONS ARE NOT FOLLOWED

03.06 Working Irregularities

<b>PROBLEM</b>	<b>PROBABLE CAUSES</b>	<b>POSSIBLE REMEDIES</b>
1. THE MOTOR STOPS	o THE THERMIC MOTOR PROTECTOR SAFETY DEVICE ("TERMICO") DISCOVERS AN OVERHEATING OF THE ELECTRIC MOTOR	o WAIT FOR ABOUT 30MIN TO ALLOW THE MOTOR TO COOL; THEN RESTART THE PROCESS
	o MALFUNCTION AND/OR BREAKAGE OF ANY ELECTRIC COMPONENT	o CONTACT THE RETAILER'S AUTHORIZED QUALIFIED TECHNICIAN
<b>HOW DO YOU KNOW THAT...</b>	<b>EVIDENCE</b>	
1. THE ELECTRIC PHASE IS NOT ACTIVE	o THE SUPPLY LINE IS MONOPHASE, SO THE DROP OF THE PHASE IMPLIES THE LACK OF ELECTRICAL CURRENT	
2. THE THERMIC SAFETY DEVICE ("TERMICO") IS ACTIVATED	o BOTH THE GREEN AND RED LEDS PRESENT ON THE CONTROL PANEL LIGHT UP	

## 04 MAINTENANCE

### 04.01 Cleaning

After using the Pizza Roller, it is essential to clean the part that comes in contact with the dough (the front piece and the 2 pairs of rollers) with a cloth and brush, using only either hot or cold water.

Ensure that before use, the above cleaning measures have been taken.

ALWAYS CLEAN THE PARTS OF THE MACHINE IN CONTACT WITH THE DOUGH WHEN THE MACHINE IS TURNED OFF AND UNPLUGGED 

### 04.02 Regular Maintenance

The Machine does not require scheduled periodic maintenance.

### 04.03 Special Maintenance

In the case of malfunctioning, strictly qualified, authorized personnel should be called.

THE MANUFACTURER CONSIDERS THE TERMS OF GUARANTEE NULL AND VOID IF UNAUTHORIZED INTERVENTIONS ARE CARRIED OUT ON THE MACHINE 

## 05 DIAGRAMS

### 05.1 Electrical Diagram

Refers to ALL. 2.

### 05.2 Spare

Parts Refers

to ALL. 3

### 05.3 Ordering Spare Parts

To order ☐ are parts, the following indications must be stated: M ☐ hine type Name of piece Position number of piece ☐ Quantity required

### 05.04 Chart of Risks

ACTIVITY/DANGER	RISK	INSTRUCTIONS
1. LOADING, UNLOADING AND MOVEMENT OF MACHINE	<ul style="list-style-type: none"><li>• DROPPING OF MACHINE</li><li>• DROPPING OF PAC-KAGING</li></ul>	<ul style="list-style-type: none"><li>• HANDLE THE MACHINE, PACKAGED OR NOT, ONLY MANUALLY</li></ul>
2. INCORRECT INSTALLATION OF MACHINE	<ul style="list-style-type: none"><li>• ELECTRICAL RUN DOWN</li><li>• ELECTRICAL BLOWING</li></ul>	<ul style="list-style-type: none"><li>• THE POWER TENSION AND THE FREQUENCY SHOULD BE THOSE STATED ON THE PLATE</li><li>• THE SOCKET MUST BE CONNECTED TO EARTH</li><li>• THE ELECTRIC POWER SUPPLY OF THE MACHINE MUST HAVE A DIFFERENTIAL SWITCH SAFETY DEVICE, COORDINATED WITH THE MAIN EARTH POWER SUPPLY</li></ul>
3. TENSION PRESENT IN CLOSED CASING	<ul style="list-style-type: none"><li>• ELECTROCUTION</li></ul>	<ul style="list-style-type: none"><li>• DO NOT OPEN THE CASING WITHOUT HAVING UNPLUGGED THE MACHINE FIRST</li></ul>
4. WORKING WITHOUT SAFETY DEVICES	<ul style="list-style-type: none"><li>• ELECTROCUTION</li><li>• ENTANGLEMENT</li><li>• CRUSHING OF FINGERS</li><li>• ABRASION</li></ul>	<ul style="list-style-type: none"><li>• DO NOT REMOVE THE SAFETY DEVICES WHEN THE MACHINE IS IN USE</li></ul>
5. CLEANING OF MACHINE PARTS IN CONTACT WITH THE DOUGH	<ul style="list-style-type: none"><li>• ELECTROCUTION</li><li>• ELECTRICAL RUN DOWNS</li><li>• ELECTRICAL BLOW OUTS</li></ul>	<ul style="list-style-type: none"><li>• CLEANING OF THE MACHINE MUST ALWAYS BE CARRIED OUT WHEN THE MACHINE IS OFF AND DISCONNECTED (UNPLUGGED FROM MAIN POWER SUPPLY)</li></ul>

ALL 1

<b>CORPO</b> <b>CASING</b> <b>CORPS</b> <b>GEHAUSE</b> <b>CUERPO</b>	Altezza • Height • Hauteur • Hohe • Altura	mm.	800
	Larghezza • Width • Largeur • Breite • Ancho	mm.	520
	Profondita • Depth • Profondeur • Tiefe • Pro-fundidad	mm.	520
	Peso Netto (circa) • Net Weight (roughly) • Poids Net (environ) • Gewicht Netto (circa) • Peso Neto (mas o menos)	Kg.	44
<b>MOTORE</b> <b>MOTOR</b> <b>MOTEUR</b> <b>MOTOR</b> <b>MOTOR</b>	Potenza • Power • Puissance • Leistung • Po-tencia	Kw	0,37
	Giri • Revolutions • Tours • Umdrehungen • Vueltas	nro/min.	1.380
	Tensione • Tension • Tension • Netzspannung • Tension	V.	230 (110 )
	Frequenza • Frequency • Frequence • Fre- quenz • Frecuencia	Hz.	50 ( 60 )
	Poli • Poles • Poles • Pole • Polos	nro	4
<b>IMBALLO</b> <b>PACKAGING</b> <b>EMBALLAGE</b> <b>VERPACK</b> <b>EMBALAJE</b>	Tipo • Type • Type • Art • Tipo	Cartone • Box • Carton • Karton • Carton	
	Altezza • Height • Hauteur • Hohe • Altura	mm.	880
	Larghezza • Width • Largeur • Breite • Ancho	mm.	535
	Profondita • Depth • Profondeur • Tiefe • Pro-fundidad	mm.	610
	Peso Lordo (circa) • Gross Weight (roughly) • Poids Brut (environ) • Bruttogewicht (circa) • Peso Bruto (mas o menos)	kg.	50 '
	Volume • Volume • Volume • Volumen • Vo-lumen	mc.	0,32

ALL 2

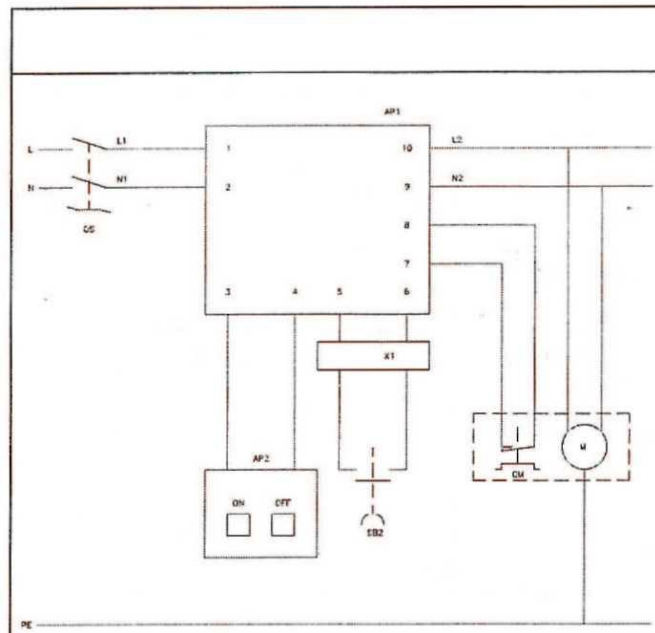

	<b>DESCRIZIONE • DESCRIPTION • DESCRPTION • BESCHREIBUNG • DESCRIPCION</b>	<b>QT.</b>
QS	INTERRUTTORE GENERALE • MAIN SWITCH • INTERRUPTEUR GENERALE • HAUPTSCHALTER • INTERRUPTOR GENERAL	1
AP1	SCHEDA DI COMANDO • CONTROL PANEL • FICHE DES COMMANDES • KONTROLLTAFEL • TAR-JETA DE MANDO	1
AP2	PULSANTI DI COMANDO IN BASSA TENSIONE • LOW TENSION CONTROL SWITCHES - BOUTON DE COMMANDE EN BASSE TENSION • KONTROLLSCHALTER FOR SCHWACHSTROM • BOTONES DE MANDO EN BAJA TENSION	1
SB1	INTERRUTTORE DI AWIAMENTO/ARRESTO MOTORE • TURN ON/ TURN OFF SWITCH • INTERRUPTEUR DE DEMARRAGE/ARRET DU MOTEUR • SCHALTER (AN UND AUS) • INTERRUPTOR DE ARRANQUE/PARADA DEL MOTOR	1
SB2	PEDALE DI AWIAMENTO/ARRESTO MOTORE • TURN ON / TURN OFF MOTOR PEDAL • PEDALE DIE DEMARRAGE/ARRET DU MOTEUR • FUUPEDAL (AN UND AUS) • PEDAL DE ARRAN-QUE/PARADA DEL MOTOR	1
X1	INNESTO PEDALE • PEDAL PLUG • PEDALE DE DEMARRAGE • FUBSCHALTERANSCHLUBDOSE • ACOPLAMIENTO PEDAL	1
M	MOTORE DI ROTAZIONE RULLI • ROLLER ROTATION MOTOR • MOTEUR DE ROTATION DES ROULEAUX • ROLLENROTATIONSMOTOR • MOTOR DE ROTACION RULOS	1
QM	PROTEZIONE TERMICA MOTORE • THERMIC MOTOR PROTECTION • PROTECTION THERMIQUE DU MOTEUR • UBERHITZUNGSSCHUTZ • PROTECCION TERMICA MOTOR	1

# BMTPS16

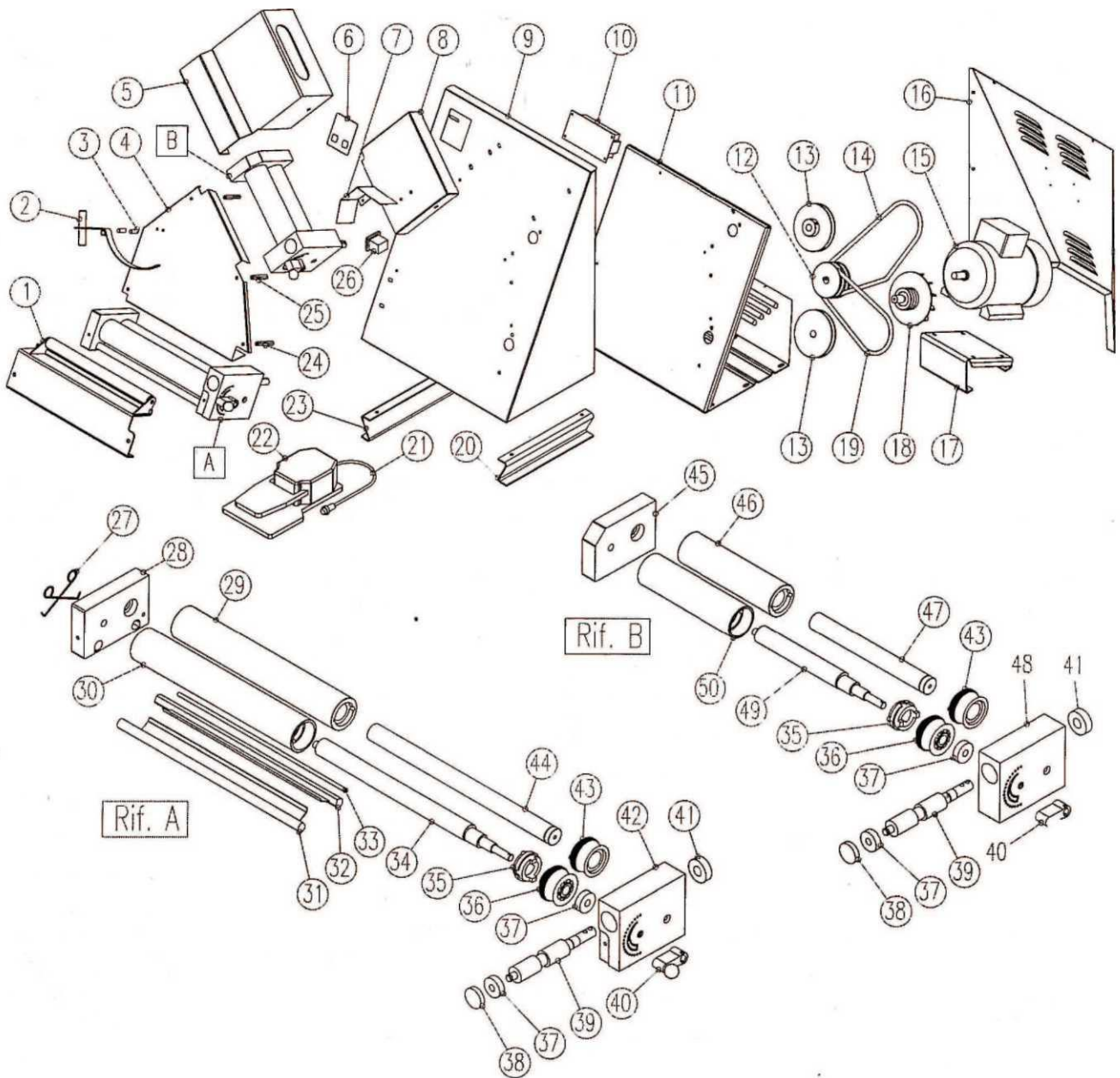



1	LOWER SAFETY DEVICE
2	SCALES
3	SCALE PIVOTS
4	PIZZA CHUTE
5	UPPER SAFETY DEVICE
6	CONTROLS
7	PLATE
8	DOUGH BALL ROLLER
9	FRAME
10	POWER CONTROL
11	SUPPORT
12	TWO GROOVE PULLEY
13	ONE GROOVE PULLEY
14	LONG BELT
15	MOTOR
16	BACK CASING
17	SUPPORT MOTOR
18	FAN UNIT
19	SHORT BELT
20	BASE
21	PEDAL CABLE
22	PEDAL
23	BASE
24	LOWER CHUTE DISTANCE PIECE
25	UPPER CHUTE DISTANCE PIECE
26	MAIN SWITCH
27	SOFT PASTA SCRAPER
28	BLOCK
29	INTERNAL ROLLER
30	EXTERNAL ROLLER
31	OUTER PASTA SCRAPER
32	INTERNAL PASTA SCRAPER
33	PROTECTION BAR
34	EXTERNAL SHAFT
35	SPIDER COUNTERSPIDER KIT
36	EXTERNAL GEARS
37	BEARING 6200
38	STOPPER
39	WORM SCREW
40	REGULATOR
41	BEARING 6202
42	BLOCK
43	INTERNAL GEARS
44	INTERNAL SHAFT
45	BLOCK
46	INTERNAL ROLLER
47	INTERNAL SHAFT
48	BLOCK
49	EXTERNAL SHAFT
50	EXTERNAL ROLLER
A	LOWER BLOCK
B	UPPER BLOCK

# Warranty & Service

BakeMax provides a 1-Year Limited Parts and Labor warranty on most items, there are select items which carry a Limited 2-Year Warranty. Extended Warranty is available on some products. Please contact us for details. The Warranty is not transferable and is limited to original installation of equipment sold by BakeMax for the original user.

For all Warranty Claims, Proof of Purchase and/or Serial Number is required. Once the machine is approved, BakeMax will provide our customers with on-site Warranty Coverage on all equipment more than 100lbs. BakeMax assumes no responsibility for down time or loss of product. Repairs must be Pre-Authorized by BakeMax and have a Service Authorization Number issued prior to commencing Warranty Service.

Warranty begins 10-Days after shipping from warehouse; delays in installation which would extend the Warranty must be Approved. All equipment must be installed and connected by Qualified Professionals in accordance with the Manual Specification. Products shipped are to be inspected at time of delivery, the receiver is responsible for inspection.

Any abuse or improper use of the equipment will void the warranty. This includes failure to follow all cleaning instructions, improper installation, improper maintenance, failure to follow capacity charts, improperly wired electrical connections. The Warranty does not apply to abuse, willful or accidental damage, or to products used for other than their intended purpose. Normal wear parts such as Accessories, Attachments, or Electrical Components such as Fuses, Bulbs, Elements, and Switches carry a 90-Day Warranty only.

**Bench Warranty (Machines Weighing 100 lb. or less)**

Once the machine is Approved for Warranty Service, if the machine requires Warranty work in less than 30 days of purchase date, BakeMax will pay all shipping charges. Once the machine is received and repaired it will be returned to the user at BakeMax expense. Freight Damages during return shipping is the responsibility of the owner of the machine.

The following is not covered under the BakeMax Warranty:

1. Overtime Labor Rates are not covered by BakeMax.
2. All parts will be shipped via Ground Courier only; If Express Shipping is required, it will be the responsibility of the Customer or Dealer.
3. Travel for Warranty Service is covered up to 100 Miles /160 Km Roundtrip, any further mileage will be the responsibility of the Customer or Dealer.
4. There is no on-site Warranty Service for Residential Addresses or addresses outside of the contiguous United States (*Lower 48*) or Canada.

*\*\*BakeMax machines sold outside of the contiguous United States (Lower 48), or Canada will carry 1-Year Parts Warranty only.*

# Terms & Conditions

## Terms

Net 15 days subject to Credit Approval. All past due Accounts are subject to 2% per month Service Charge as per Credit Application. We accept Visa, MasterCard, and Discover Credit Cards. We also accept E-Transfer & Wire Transfer, additional fees may apply.

## Pricing

All prices are subject to change without notice. All prices are Sales Tax Extra, should you be claiming Tax Exemption, Tax Exempt Forms must accompany your Purchase Order. BakeMax products are sold in Canadian and US Dollars. BakeMax is not responsible for specifications errors or printing errors.

## Shipping

Free shipping to Canada and the U.S. Minimum order \$6,000 for BakeMax and \$10,000 for BakeMax America Cooking Line. Tailgate Delivery is \$90.00 minimum. All checks made Payable to Titan Ventures International Inc. BakeMax is not responsible for goods damaged during shipping. BakeMax is not responsible for any delays in delivery once product has left our Warehouse and is in the carrier's possession. Products shipped are to be inspected at time of delivery, the receiver is responsible for inspection. Damaged Freight Claims are to be claimed with the carrier. BakeMax assumes no responsibility for Damaged Freight. Shipping Insurance available by request. By signing your name on the delivery receipt without noting any damages, you are stating that you have received your shipment in Acceptable Condition.

## Return Policy

Returns will not be Approved unless in Writing. Returns must be made within 30-Days of Purchase and must have a Return Authorization Number issued before returning. The purchase order number, reason for return, and the serial number(s) of the unit are required for the Return Authorization Number. Minimum return amount of \$100.00.

Returns are subject to a minimum restocking fee of 30%. The cost of any repairs or re-crating required will be charged back to the dealer. If there is a manufacturer's defect BakeMax® will pay standard freight returned and prepaid shipping back to the customer.

Special Order Items, Clearance / Discontinued Equipment, Parts, Refurbished/Demo Equipment, or Non-Standard items are not Returnable.

## Ordering Information

Send purchase orders to BakeMax via e-mail [orderdesk@bakemax.com](mailto:orderdesk@bakemax.com) or Fax (506-859-6929). Use Model or Part number when ordering including Voltage Requirements, and Product Description. Please include the Dealer, Name, Address, terms, special delivery, or instructions required or attention names to be applied to packaging. Please notify BakeMax should you need order confirmation or tracking numbers, by calling 1-800-565-2253 or email [orderdesk@bakemax.com](mailto:orderdesk@bakemax.com).

## Special Terms and Conditions

BakeMax reserves the right to make improvements or equipment changes without prior permission. Setup and Installation are the end user's Responsibility. Failure to properly Install or Maintain Equipment may Void Warranty.

## Catalog, Spec Sheets and Website

BakeMax is not liable for incorrect information found in our Catalog, Spec Sheets or Website. Please contact us to confirm specifications. Pictures and specifications are for general purposes only. Product may not be exactly as shown. Prices and availability may change at any time without notice. Dimensions shown may change at any time without notice.